

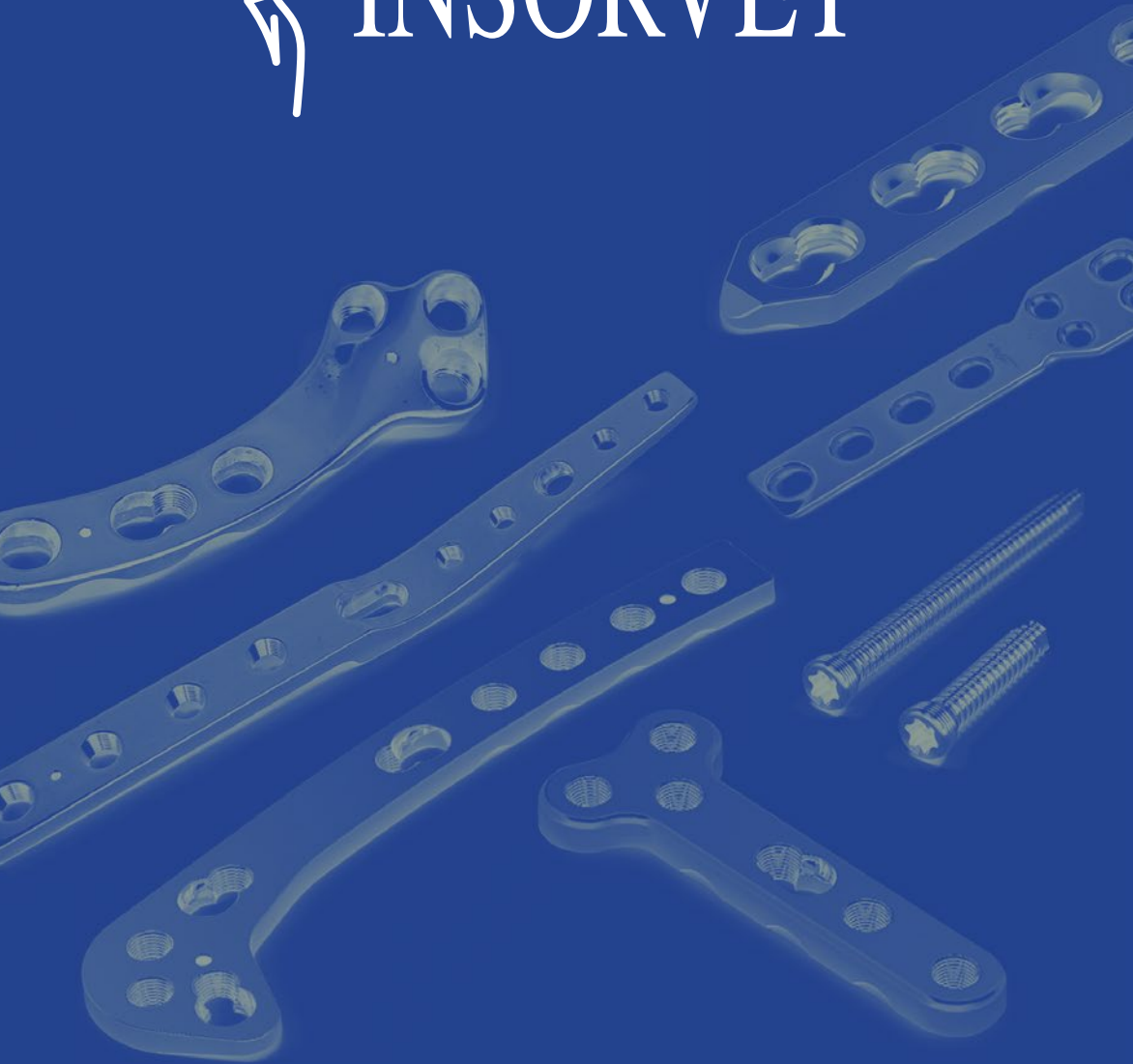

INSORVET



Instrumental Ortopedia Veterinaria
Veterinary Orthopedic Instruments

CATÁLOGO | CATALOG



Insorvet, nació en 1996 con la intención de desarrollar nuevos implantes e Instrumental y otros implantes que nos permitiese mejorar el tratamiento de los problemas ortopédicos y de traumatología de pequeños animales a los que nos enfrentamos en nuestra práctica clínica. Gracias por confiar en nuestros productos, en nuestra innovación, investigación y mejora de los actuales implantes empleados en la traumatología y ortopedia de pequeños animales.

***Insorvet** was founded in 1996 with the objective of developing new implants and instruments to allow for the improvement of the treatment of the orthopaedic and traumatology problems observed in our veterinary practice. Thank you for trusting in our products, in our innovation, research and improvement of the current implants used in traumatology and orthopaedics of small animals.*

Tornillos corticales autoroscantes 9

Cortical self-taping screws 9

Placas convencionales

Conventional plates

Placas rectas cortables 13

Cut-to-length plate 13

Placas DCP 13

DCP plates 13

Placas de reconstrucción 17

Reconstruction plate 17

Placas en T 17

T plates 17

Placas en L 19

L plates 19

Placas oblicuas 19

Oblique Plate 19

Placas orificios redondos 19

Round hole plates 19

Placas sostén 21

Butress plates 21

Placas CTWO 23

CTWO plates 23

Placas cobra 23

Cobra plates 23

Placas bandera 25

Flag plates 25

Placas acetabulares 25

Acetabular plates 25

Puentes 25

Bridges 25

Placas fracturas supracondilares de fémur 27

Supracondilar femoral fractures plates 27

Placas triple osteotomía de cadera 27

Triple pelvic osteotomy plates 27

Placa síndrome compartimento medial del codo 27

Medial compartment disease plates 27

Hybrid plates for tarsal panarthrode 29

Placas híbridas de panartrodesis de tarso 29

Porous titanium wedges and their instruments 29

Cuñas de titanio poroso y su Instrumental 29

Steel TTA inclined arm plates and feed separator 31

Placas de brazo inclinado TTA de acero y separador de avance 31

Straight Carpal Panarthrodesis Hybrid Plates 33

Placas híbridas panartrodesis carpal rectas 33

Stepped hybrid plates for carpal panarthrodesis 33

Placas híbridas panartrodesis carpal escalonadas 33

Placas bloqueadas de tornillos de cortical

Placas bloqueadas rectas de bajo contacto	34
Placa bloqueada de reconstrucción	34
Placa bloqueada en T	34
Placas bloqueadas sostén	35
Placas bloqueadas para la osteotomía craneal de la tibia (cuña) y otras aplicaciones	36
Placas cobra	36
Placas bandera	36
Placas acetabulares	36
Placas doble/triple osteotomía de cadera	37
Placa síndrome compartimento medial del codo	37
Placas de bloqueo panartrodesis carpal escalonadas	37

Placas de bloqueo tornillos cónicos

Placas rectas cortables	39
Tornillos de bloqueo	41
Placas múltiples orificios	43
Placas de sostén	45
Placas síndrome compartimento medial del codo	45
Placas acetabulares	45
Placas en T	47
Placas CTWO (cobras y banderas)	49
Placas cobra	49
Placas bandera	49
Placas supracondilares de fémur	51
Placas en forma de stick	51
Placas en forma palo de golf	51
Placas panartrodesis carpal escalonadas	51
Placas TPLO	53
Rectas	53
Curvadas	53
Placas panartrodesis tarsal	55

Screw locked plates cortical

Low contact locking plates	34
Cut to length reconstruction locking	34
Locking t plates	34
Butress locking-plate	35
Locking Plates for Cranial Tibia Osteotomy and Other Applications	36
Cobra plates	36
Flag plates	36
Acetabular plates	36
Double/triple pelvic osteotomy plates	37
Medial compartment disease plates	37
Stepped hybrid locking plates for carpal panarthrodesis	37

Locking screws

Cutttable straight plates	39
Locking screws	41
Multiple hole plates	43
Support plates	45
Plates for medial elbow compartment disease	45
Acetabular plates	45
T plates	47
CTWO plates (cobra and flags)	49
Cobra plates	49
Flag plates	49
Supracondylar plates of fémur	51
Stick-shaped plates	51
Golf club shaped plates	51
Staggered carpal panarthrodesis plates	51
TPLO plate	53
Straight	53
Curved	53
Tarsal panarthrodesis plates	55

Instrumental y otros implantes

Clavos cerrojados	57
Rótulas simples	58
Barras conectoras	58
Rótulas dobles	58
Elongador de hueso cuadrado	59
Agujas	59
Arpones	60
Brocas	61
Guías de broca	61
Rollos cerclajes	62
Atornillador	62
Retractores de Kishigamy	62
Mango Anclaje rápido	63
Pasamachos	63
Extractor de Tornillos	64
Fresas	64
Arandelas	64
Casquillos sujeta nylon	65
Meniscotomo	65
Osteotomo	65
Cucharilla Volkman doble	66
Mango hojas osteotomo	66
Hoja osteótomo	66
Llave	66
Gúbia recta	66
Pinzas Kern	67
Hohmann retractor	67
Pinza sujeción hueso	67
Distractor rodilla	67
Pinzas Verbrugge	67
Pinzas Heiss	68
Pinzas Babcock	68
Pinzas Ruskin Corta Hueso	68
Alicates Liston Corta Hueso	68
Pinzas para tejidos Allis	68
Pinzas hemostáticas Mosquito	68
Pinzas hemostáticas Kocher	68
dentadas recta	69
Separador Weitlaner con punta roma	69

Instrumental and other implants

Interlocking nails	57
Single connecting bars clamps	58
Connecting bars length (280 mmm)	58
Double connecting bars clamps	58
Squared bone lengthening	59
Needle	59
Harpoon	60
Drill	61
Drill guides	61
Rolls of soft wire	62
Screwdriver	62
Kishigamy retractor	62
Quick fit / Strait handle with quick fit	63
Tap	63
Screw	64
Drills	64
Washers	64
Nylon retaining caps	65
Meniscotomo	65
Bone chisel	65
Double Volkman spoon	66
hisel Handle	66
Blade chisel	66
Wrench	66
Ruskin rongeurs	66
Kern bone holding forceps	67
Hohmann retractor	67
Reduction forceps with serrated jaw with speed lock	67
Knee distractor	67
Forceps Verbrugge	67
Heiss vascular clamp	68
Forceps Babcock	68
Ruskin bone cutting forceps	68
Liston bone cutting fórceps	68
Allis tissue seizing forceps	68
Mosquito hemostatic foceps	68
Kocher hemostatic straight forceps	69
Weitlaner retractor	69

Pinzas laminectomía	69	<i>Laminectomy cutting forceps</i>	69
Cizalla corte clavos	69	<i>Rod cutter</i>	69
Alicate de corte	70	<i>Wire-cutter</i>	70
Alicate corte puntas de tungsteno	70	<i>Wire-cutter tungsten point</i>	70
Alicate Hércules hojas intercambiables	70	<i>Wire-cutter tungsten point</i>	70
Alicate bloqueo	70	<i>Locking pliers</i>	70
Alicate doblado placas pequeñas	70	<i>Universal bending pliers</i>	70
Porta-agujas	71	<i>Needle holder</i>	71
Pinzas	71	<i>Forceps</i>	71
Tijeras	71	<i>Scissors</i>	71
Raspa para huesos Putti	72	<i>Putti bone rasp</i>	72
Separador	72	<i>Separador / Retractor</i>	72
Trefina de Michele	72	<i>Trefina de Michele / Michele trephine</i>	72
Sierra de Gigli	72	<i>Sierra de Gigli / Gigli saw</i>	72
Impactador de grapas	73	<i>H. Ros impactor driver</i>	73
Extractor de grapas	73	<i>H. Ros staples elevator</i>	73
Portabrocas inoxidable	73	<i>Stainless steel drill</i>	73
Pasahilo grande ojal en ambas puntas	73	<i>Big Cable passer</i>	73
Grifas	73	<i>Bending iron</i>	73
Medidor de agujas, brocas y tornillos	73	<i>Screw / Gauge for drill bits, Kirchner wires and screws</i>	73
Grapas de epifísis	74	<i>Epyphisis staples</i>	74
Guías de broca dentadas	74	<i>Double drill sleeve</i>	74
Guía para controlar desviaciones en las osteotomías	74	<i>Jig to avoid deviations in osteotomies</i>	74
Periostotomos	74	<i>Periostal elevator</i>	74
Separadores	75	<i>Separators</i>	75
Caja de tornillos	75	<i>Screws box</i>	75





Tornillos de cortical
Cortical screws

Tornillos corticales autoroscantes

Cortical self-taping screws

Ø 1,5 mm

Ref.	Long.
0015-006	6 mm
0015-007	7 mm
0015-008	8 mm
0015-009	9 mm
0015-010	10 mm
0015-011	11 mm
0015-012	12 mm

Ref.	Long.
0015-014	14 mm
0015-016	16 mm
0015-018	18 mm
0015-020	20 mm
0015-022	22 mm
0015-024	24 mm

Ø 2 mm

Ref.	Long.
0020-006	6 mm
0020-008	8 mm
0020-010	10 mm
0020-012	12 mm
0020-014	14 mm
0020-016	16 mm

Ref.	Long.
0020-018	18 mm
0020-020	20 mm
0020-022	22 mm
0020-024	24 mm
0020-026	26 mm
0020-028	28 mm

Ref.	Long.
0020-030	30 mm
0020-032	32 mm
0020-034	34 mm
0020-036	36 mm
0020-038	38 mm
0020-040	40 mm

Ø 2,4 mm

Ref.	Long.
0024-006	6 mm
0024-008	8 mm
0024-010	10 mm
0024-012	12 mm
0024-014	14 mm
0024-016	16 mm

Ref.	Long.
0024-018	18 mm
0024-020	20 mm
0024-022	22 mm
0024-024	24 mm
0024-026	26 mm
0024-028	28 mm

Ref.	Long.
0024-030	30 mm
0024-032	32 mm
0024-034	34 mm
0024-036	36 mm
0024-038	38 mm
0024-040	40 mm



Tornillos de cortical
Cortical screws

Tornillos corticales autoroscantes

Cortical self-taping screws

Ø 2,7 mm

Ref.	Long.
0027-006	6 mm
0027-008	8 mm
0027-010	10 mm
0027-012	12 mm
0027-014	14 mm
0027-016	16 mm

Ref.	Long.
0027-018	18 mm
0027-020	20 mm
0027-022	22 mm
0027-024	24 mm
0027-026	26 mm
0027-028	28 mm

Ref.	Long.
0027-030	30 mm
0027-032	32 mm
0027-034	34 mm
0027-036	36 mm
0027-038	38 mm
0027-040	40 mm

Ø 3,5 mm

Ref.	Long.
0035-010	10 mm
0035-012	12 mm
0035-014	14 mm
0035-016	16 mm
0035-018	18 mm
0035-020	20 mm
0035-022	22 mm

Ref.	Long.
0035-024	24 mm
0035-026	26 mm
0035-028	28 mm
0035-030	30 mm
0035-032	32 mm
0035-034	34 mm
0035-036	36 mm

Ref.	Long.
0035-038	38 mm
0035-040	40 mm
0035-045	45 mm
0035-050	50 mm
0035-060	60 mm

Ø 4,5 mm

Ref.	Long.
0045-010	10 mm
0045-012	12 mm
0045-014	14 mm
0045-016	16 mm
0045-018	18 mm
0045-020	20 mm
0045-022	22 mm
0045-024	24 mm

Ref.	Long.
0045-026	26 mm
0045-028	28 mm
0045-030	30 mm
0045-032	32 mm
0045-034	34 mm
0045-036	36 mm
0045-038	38 mm
0045-040	40 mm

Ref.	Long.
0045-042	42 mm
0045-044	44 mm
0045-046	46 mm
0045-048	48 mm
0045-050	50 mm
0045-052	52 mm
0045-054	54 mm
0045-056	56 mm



Placas rectas cortables
Cuttable straight plates



Placas DCP
DCP plates



Placas convencionales

Conventional plates

Placas rectas cortables / Cut-to-length plate

Ref.	Tornillo/Screw	Ancho/width	Grosor/Thickness	Long.	Orificios/Holes
1515E-020	Ø 1,5 mm	4 mm	1,5 mm	100 mm	20 ○
1515A-020	Ø 1,5 mm	5 mm	1,5 mm	100 mm	20 ○
2020-020	Ø 2 mm	5,5 mm	1,5 mm	100 mm	20 ○
2020-025	Ø 2 mm	7,5 mm	2 mm	150 mm	25 ○
2727-020	Ø 2,7 mm	7,5 mm	2,5 mm	140 mm	18 ○

- Orificios redondos / round holes
 ○ Orificios ovalados / oval holes

Placas DCP / DCP plates

Para tornillo / For screw: Ø 1,5 mm
 Ancho / Width: 4 mm
 Grosor / Thickness: 1,5 mm

Ref.	Long.	Orificios Holes
1515-004	23,5 mm	4
1515-005	28,5 mm	5
1515-006	33,5 mm	6
1515-007	38,5 mm	7
1515-008	43,5 mm	8
1515-009	48,5 mm	9
1515-010	53,5 mm	10
1515-011	58,5 mm	11
1515-012	63,5 mm	12

Para tornillo / For screw: Ø 2 mm
 Ancho / Width: 5 mm
 Grosor / Thickness: 1,5 mm

Ref.	Long.	Orificios Holes
2020-004	22 mm	4
2020-005	27 mm	5
2020-006	32 mm	6
2020-007	37 mm	7
2020-008	42 mm	8
2020-009	48 mm	9
2020-010	65 mm	10
2020-011	71 mm	11
2020-012	76 mm	12

Para tornillo / For screw: Ø 2,4 mm
 Ancho / Width: 6,7 mm | Grosor / Thickness: 2,5 mm

Ref.	Long.	Orificios/Holes	Ref.	Long.	Orificios/Holes
2424-004	31,15 mm	4	2424-009	66,15 mm	9
2424-005	38,15 mm	5	2424-010	73,15 mm	10
2424-006	45,15 mm	6	2424-011	80,15 mm	11
2424-007	52,15 mm	7	2424-012	87,15 mm	12
2424-008	59,15 mm	8			



Placas DCP
DCP plates



Placas convencionales / Conventional plates

Para tornillo / For screw: Ø 2,7 mm

Ancho / Width: 8 mm | Grosor / Thickness: 3 mm

Ref.	Long.	Orificios/Holes
2727-004	36 mm	4
2727-005	44 mm	5
2727-006	52 mm	6
2727-007	60 mm	7
2727-008	68 mm	8

Ref.	Long.	Orificios/Holes
2727-009	76 mm	9
2727-010	84 mm	10
2727-011	92 mm	11
2727-012	100 mm	12

Para tornillo / For screw: Ø 3,5 mm

Ancho / Width: 10,2 mm

Grosor / Thickness: 4 mm

Ref.	Long.	Orificios/Holes
3535E-004	49 mm	4
3535E-005	61 mm	5
3535E-006	73 mm	6
3535E-007	85 mm	7
3535E-008	97 mm	8
3535E-009	109 mm	9
3535E-010	121 mm	10
3535E-011	133 mm	11
3535E-012	145 mm	12

Para tornillo / For screw: Ø 3,5 mm

Ancho / Width: 12 mm

Grosor / Thickness: 4 mm

Ref.	Long.	Orificios/Holes
3535A-004	49 mm	4
3535A-005	61 mm	5
3535A-006	73 mm	6
3535A-007	85 mm	7
3535A-008	97 mm	8
3535A-009	109 mm	9
3535A-010	121 mm	10
3535A-011	133 mm	11
3535A-012	145 mm	12

Para tornillo / For screw: Ø 4,5 mm

Ancho / Width: 12 mm | Grosor / Thickness: 5 mm

Ref.	Long.	Orificios/Holes
4545-004	71 mm	4
4545-005	87 mm	5
4545-006	103 mm	6
4545-007	119 mm	7
4545-008	135 mm	8
4545-009	151 mm	9
4545-010	167 mm	10
4545-011	183 mm	11

Ref.	Long.	Orificios/Holes
4545-012	199 mm	12
4545-013	216 mm	13
4545-014	231 mm	14
4545-015	247 mm	15
4545-016	263 mm	16
4545-017	279 mm	17
4545-018	195 mm	18



Placas de reconstrucción
Reconstruction plate



Placas en T
T plates



Placas convencionales / Conventional plates

Placas de reconstrucción / Reconstruction plate

Para tornillo / For screw: Ø 1,5 mm
Ancho / Width: 4 mm
Grosor / Thickness: 1,3 mm

Ref.	Long.	Orificios/Holes
15RC-020	100 mm	20 

Para tornillo / For screw: Ø 2 mm
Ancho / Width: 5 mm
Grosor / Thickness: 2,7 mm

Ref.	Long.	Orificios/Holes
20RC-021	150 mm	30 

Para tornillo / For screw: Ø 2,7 mm
Ancho / Width: 7 mm
Grosor / Thickness: 2 mm

Ref.	Long.	Orificios/Holes
27RC-022	150 mm	25 

Para tornillo / For screw: Ø 2,7 mm
Ancho / Width: 8 mm
Grosor / Thickness: 2.8 mm

Ref.	Long.	Orificios/Holes
27RC-023	190 mm	24 

Para tornillo / For screw: Ø 3,5 mm
Ancho / Width: 10 mm
Grosor / Thickness: 3,5 mm

Ref.	Long.	Orificios/Holes
35RC-024	260 mm	22 

-  Orificios redondos / round holes
 Orificios ovalados / oval holes

Placas en T / T plates

Ref.	Tornillo Screw	Long. Length	Ancho cabeza Head width	Ancho cola width plate shaft	Grosor Thickness
T-15	Ø 1,5 mm	27 mm	7 mm	4 mm	1,5 mm
T-20C	Ø 2 mm	28 mm	9 mm	5 mm	1,5 mm
T-20L	Ø 2 mm	35 mm	9 mm	5 mm	1,5 mm
2020-041	Ø 2 mm	22 mm	12 mm	5 mm	1,5 mm
T-27	Ø 2,7 mm	55 mm	12,5 mm	7 mm	2,5 mm
T-27C	Ø 2,7 mm	40 mm	16 mm	8 mm	2,5 mm
2727-041	Ø 2,7 mm	30 mm	13 mm	7 mm	0,9 mm
T-35	Ø 3,5 mm	80 mm	18 mm	11 mm	3 mm
T-35C	Ø 3,5 mm	55 mm	22 mm	10 mm	3 mm
T-35L	Ø 3,5 mm	78 mm	24 mm	12 mm	3 mm



Placas en L
L plates



Placas oblicuas
Oblique Plate



Placas orificios redondos
Round hole plates



Placas convencionales / Conventional plates

Placas en L / L plates

Ref.	Tornillo/Screw	Grosor / Thickness	Orientación / Orientation
2020-031	Ø 2 mm	0,9 mm	└ izquierda / left
2020-032	Ø 2 mm	0,9 mm	┌ derecha / right
2727-031	Ø 2,7 mm	0,9 mm	└ izquierda / left
2727-032	Ø 2,7 mm	0,9 mm	┌ derecha / right

Placas oblicuas / Oblique Plate

Ref.	Tornillo/Screw	Grosor / Thickness	Orientación / Orientation
2020-033	2 mm	0,9 mm	└ izquierda / left
2020-034	2 mm	0,9 mm	┌ derecha / right
2727-033	2,7 mm	0,9 mm	└ izquierda / left
2727-034	2,7 mm	0,9 mm	┌ derecha / right

Placas orificios redondos / Round hole plates

Para tornillo / For screw: Ø 2,0/2,4/2,7 mm

Ancho / Width: 7 mm | Grosor / Thickness: 2 mm

Ref.	Long.	Orificios/Holes
2027-004	34 mm	4
2027-005	40 mm	5
2027-006	46 mm	6
2027-007	52 mm	7
2027-008	58 mm	8

Ref.	Long.	Orificios/Holes
2027-009	64 mm	9
2027-010	70 mm	10
2027-011	73 mm	11
2027-012	78 mm	12



Placas sostén
Butress plates

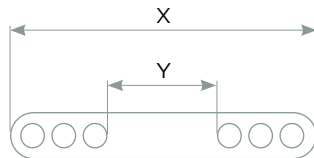

Placas convencionales / Conventional plates

Placas sostén / Butress plates

Para tornillo / For screw: Ø 2 mm

Ancho / Width: 7,0 mm | Grosor / Thickness: 2 mm

Ref.	Long. X	Long. Y	Orificios/Holes
2020-070	70 mm	31,4 mm	3 – 3
2020-080	80 mm	41,4 mm	3 – 3
2020-090	90 mm	41,4 mm	4 – 4
2020-100	100 mm	51,4 mm	4 – 4

Para tornillo / For screw: Ø 2,4 mm

Ancho / Width: 7 mm | Grosor / Thickness: 2,5 mm

Ref.	Long. X	Long. Y	Orificios/Holes
2424-070	70 mm	30,5 mm	3 – 3
2424-080	80 mm	40,5 mm	3 – 3
2424-090	90 mm	50,5 mm	4 – 4
2424-100	100 mm	60,5 mm	4 – 4

Para tornillo / For screw: Ø 2,7 mm

Ancho / Width: 80 mm | Grosor / Thickness: 2,5 mm

Ref.	Long. X	Long. Y	Orificios/Holes
2727-070	70 mm	27 mm	3 – 3
2727-080	80 mm	37 mm	3 – 3
2727-090	90 mm	33 mm	4 – 4
2727-100	100 mm	43 mm	4 – 4
2727-110	110 mm	53 mm	4 – 4
2727-120	120 mm	63 mm	4 – 4
2727-130	130 mm	73 mm	4 – 4

Placas sostén
Butress plates

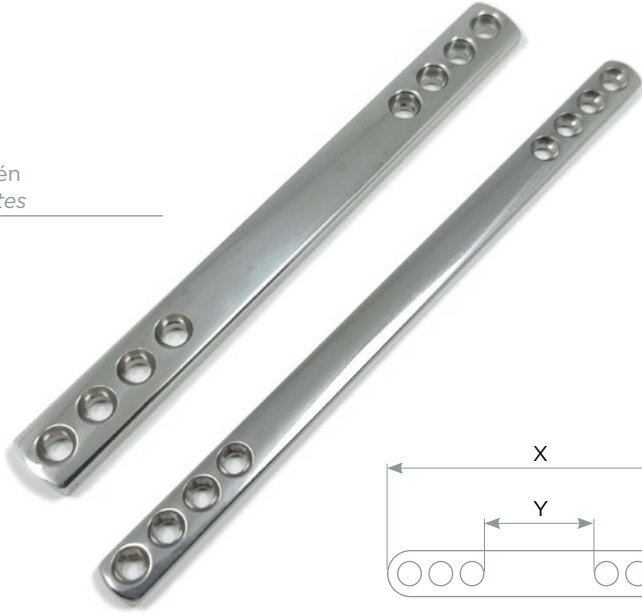

Placas cobra
Cobra plates



Placas convencionales / Conventional plates

Para tornillo / For screw: Ø 3,5 mm
Ancho / Width: 10,2 mm
Grosor / Thickness: 3,2 mm

Ref.	Long. X	Long. Y	Orificios Holes
3535E-100	100 mm	34,4 mm	4
3535E-120	120 mm	54,4 mm	4
3535E-140	140 mm	74,4 mm	4
3535E-160	160 mm	94,4 mm	4

Para tornillo / For screw: Ø 3,5 mm
Ancho / Width: 12 mm
Grosor / Thickness: 3,2 mm

Ref.	Long. X	Long. Y	Orificios Holes
3535A-100	100 mm	34,4 mm	4
3535A-120	120 mm	54,4 mm	4
3535A-140	140 mm	74,4 mm	4
3535A-160	160 mm	94,4 mm	4
3535A-180	180 mm	114,4 mm	4

Para tornillo / For screw: Ø 4,5 mm
Ancho / Width: 12 mm | Grosor / Thickness: 4 mm

Ref.	Long. X	Long. Y	Orificios/Holes
4545-100	100 mm	26,2 mm	4
4545-120	120 mm	46,2 mm	4
4545-140	140 mm	66,2 mm	4
4545-160	160 mm	86,2 mm	4
4545-180	180 mm	106,2 mm	4

Placas CTWO / CTWO plates

Placas cobra / Cobra plates

Ref.	Long.	Cabeza Head	Cola Plate shaft	Grosor Thickness	Tornillo Screw
CTWO-20	39 mm	10 mm	6 mm	2 mm	2 mm
CTWO-24	42,5 mm	12 mm	6,5 mm	2,5 mm	2,4 mm
CTWO-27C	48 mm	14 mm	8 mm	2,5 mm	2,7 mm
CTWO-27L	59 mm	16 mm	10 mm	2,5 mm	2,7 mm
CTWO-27G	66 mm	17 mm	11 mm	2,5 mm	2,7 mm
CTWO-3	67 mm	18 mm	12 mm	3 mm	3,5 mm
CTWO-4	79 mm	18 mm	12 mm	3 mm	3,5 mm
CTWO-5	92 mm	18 mm	12 mm	3 mm	3,5 mm
CTWO-4SF	78 mm	16 mm	12 mm	3 mm	3,5 mm



Placas bandera
Flag plates



Placas acetabulares
Acetabular plates



Puentes
Bridges



Placas convencionales / Conventional plates

Placas bandera / Flag plates

Ancho cabeza / Width head: 24 mm | Ancho cola / Plate shaft: 12 mm
Grosor / Thickness: 3 mm

Ref.	Tornillo Screw	Long.	Bandera Flag	Orificios en cola/Holes
CTWO-D3	Ø 3,5 mm	67	┌ derecha / right	3
CTWO-I3	Ø 3,5 mm	67	└ izquierda / left	3
CTWO-D4	Ø 3,5 mm	80	┌ derecha / right	4
CTWO-I4	Ø 3,5 mm	80	└ izquierda / left	4
CTWO-D5	Ø 3,5 mm	92	┌ derecha / right	5
CTWO-I5	Ø 3,5 mm	92	└ izquierda / left	5

Ancho cabeza / Width head: 28 mm | Ancho cola / Plate shaft: 13 mm
Grosor / Thickness: 4 mm

Ref.	Tornillo Screw	Long.	Bandera Flag	Orificios en cola Holes
CTWO-DG	Ø 3,5 mm	110	┌ derecha / right	5
CTWO-IG	Ø 3,5 mm	110	└ izquierda / left	5

Placas acetabulares / Acetabular plates

Ref.	Tornillo Screw	Long.	Grosor Thickness
ACT-020	Ø 2 mm	25 mm	2 mm
ACT-027	Ø 2,7 mm	38 mm	2,5 mm
ACT-035	Ø 3,5 mm	44 mm	3 mm

Puentes / Bridges

Ref.	Puente/Bridges
P6	6 mm
P9	9 mm
P12	12 mm
P15	15 mm



Placas fracturas
supracondilares de fémur
*Supracondilar femoral
fractures plates*



Placa Miami
Miami plate



Placas fracturas supracondilares de fémur

Supracondilar femoral fractures plates

Fémur derecho / Right femoral

Ref.	Long.	Ancho/Width	Grosor/Thickness
FED-20	51 mm	6 mm	1,5 mm
FED-27	71 mm	8 mm	2,5 mm
FED-35E	10,5 mm	10 mm	4 mm
FED-35A	13,5 mm	12,5 mm	4 mm

Fémur izquierdo / Left femoral

Ref.	Long.	Ancho/Width	Grosor/Thickness
FEI-20	51 mm	6 mm	1,5 mm
FEI-27	71 mm	8 mm	2,5 mm
FEI-35E	10,5 mm	10 mm	4 mm
FEI-35A	13,5 mm	12,5 mm	4 mm

Placas triple osteotomía de cadera

Triple pelvic osteotomy plates

Placa Miami de /
Miami plate 24°
Orificios / Holes 10

Ref.	Orientación / Orientation
2582-012	Derecha / Right
2582-112	Izquierda / Left

Izquierdo / Left

Ref.	Grados/ Degrees	Tornillo/ Screw
2581-027	25°	2,7 mm
2581-020	20°	3,5 mm
2581-030	30°	3,5 mm
2581-040	40°	3,5 mm

Derecha / Right

Ref.	Grados/ Degrees	Tornillo/ Screw
2580-027	25°	2,7 mm
2580-020	20°	3,5 mm
2580-030	30°	3,5 mm
2580-040	40°	3,5 mm

Placa síndrome compartimento medial del codo / Medial compartment disease plates

Ref.	Long. total	Orificio/Hole	Tornillo/Screw
MCD-02	70 mm	2,5 mm	3,5 mm

Placas híbridas de
panartrodesis de tarso /
*Hybrid plates for tarsal
panarthrode*



Cuña
Wedges



Instrumental y otros implantes



DIS-TTA



GS-TTA

INSORVET

Placas híbridas de panartrodesis de tarso

Hybrid plates for tarsal panarthrodesis

Lateral izquierdo / Left side

Ref.	Tornillo/Screw	
	Proximal	Distal
T35-035I	Ø 3,5 mm	Ø 3,5 mm
T30-27I	Ø 3,5 mm	Ø 2,7 mm
T35-027I	Ø 3,5 mm	Ø 2,7 mm
T27-020I	Ø 2,7 mm	Ø 2 mm
T20-020I	Ø 2 mm	Ø 2 mm
T20-015I	Ø 2 mm	Ø 1,5 mm
TG24-20I*	Ø 2,4 mm	Ø 2 mm
TG20-15I*	Ø 2,4 mm	Ø 1,5 mm

Lateral derecho / Right side

Ref.	Tornillo/Screw	
	Proximal	Distal
T35-035D	Ø 3,5 mm	Ø 3,5 mm
T30-27D	Ø 3,5 mm	Ø 2,7 mm
T35-027D	Ø 3,5 mm	Ø 2,7 mm
T27-020D	Ø 2,7 mm	Ø 2 mm
T20-020D	Ø 2 mm	Ø 2 mm
T20-015D	Ø 2 mm	Ø 1,5 mm
TG20-020D*	Ø 2,4 mm	Ø 2 mm
TG20-015D*	Ø 2,4 mm	Ø 1,5 mm

*Para gatos/For cats

Cuñas de titanio poroso y su instrumental

Porous titanium wedges and their instruments

Cuña / Wedges

Ref.	Long.
CTP-3	3 mm
CTP-4,5	4,5 mm
CTP-6	6 mm
CTP-7,5	7,5 mm
CTP-9	9 mm
CTP-10,5	10,5 mm
CTP-12	12 mm
CTP-13,5	13,5 mm
CTP-15	15 mm

Instrumental

Ref.	Descripción / Description
DIS-TTA	Distractor para TTA
GS-TTA	Guía de hoja sierra
CTP-BG	Base guía
CTP-V	Varillas
CTP-P	Perno
CTP-A	Plantilla agujas
CTP-CI	Conjunto Instrumental y otros implantes (base guía, 2 varillas, perno y plantilla agujas)



Placa TTA
TTA Plate



Separador de avance
Forward separator



Placas de brazo inclinado TTA de acero y separador de avance / Steel TTA inclined arm plates and feed separator

Placa TTA / TTA Plate

Ref.	Nº
ATT-BI1	1
ATT-BI2	2
ATT-BI3	3
ATT-BI4	4
ATT-BI5	5
ATT-BI6	6
ATT-BI7	7
ATT-BI8	8

Separador de avance Forward separator

Ref.	Dimensiones Dimensions
S-3-7D	3 x 7 mm
S-3-10D	3 x 10 mm
S-4,5-7D	4,5 x 7 mm
S-4,5-9D	4,5 x 9 mm
S-4,5-12D	4,5 x 12 mm
S-6-13D	6 x 13 mm
S-6-16D	6 x 16 mm
S-6-19D	6 x 19 mm
S-7,5-16D	7,5 x 16 mm
S-7,5-19D	7,5 x 19 mm
S-9-19D	9 x 19 mm
S-9-22D	9 x 22 mm
S-10,5-19D	10,5 x 19 mm
S-10,5-22D	10,5 x 22 mm
S-12-19D	12 x 19 mm
S-12-22D	12 x 22 mm
S-12-25D	12 x 25 mm

De titanio / Titanium

Placa TTA / TTA Plate

Ref.	Nº
TTT-BI1	1
TTT-BI2	2
TTT-BI3	3
TTT-BI4	4
TTT-BI5	5
TTT-BI6	6
TTT-BI7	7
TTT-BI8	8

Separador de avance Forward separator

Ref.	Dimensiones Dimensions
TS-3-7D	3 x 7 mm
TS-3-10D	3 x 10 mm
TS-4,5-7D	4,5 x 7 mm
TS-4,5-9D	4,5 x 9 mm
TS-4,5-12D	4,5 x 12 mm
TS-6-16D	6 x 16 mm
TS-6-19D	6 x 19 mm
TS-7,5-16D	7,5 x 16 mm
TS-9-19D	9 x 19 mm
TS-9-22D	9 x 22 mm
TS-10,5-19D	10,5 x 19 mm
TS-10,5-22D	10,5 x 22 mm
TS-12-25D	12 x 25 mm



Placas híbridas panartrodesis
carpal rectas
*Straight Carpal Panarthrodesis
Hybrid Plates*



Placas híbridas panartrodesis
carpal escalonadas / *Stepped
hybrid plates for carpal
panarthrodesis*



Placas híbridas panartrodesis carpal rectas
Straight Carpal Panarthrodesis Hybrid Plates

Ref.	Tornillo/Screw	Long.
P35-035L	3,5 - 3,5 mm	152 mm
P35-035	3,5 - 3,5 mm	140 mm
P35-027L	3,5 - 2,7 mm	118 mm
P35-027C	3,5 - 2,7 mm	100 mm
P27-020L	2,7 - 2 mm	80 mm
P27-020C	2,7 - 2 mm	76 mm
P20-020	2 - 2 mm	57 mm
P20-015*	2 - 1,5 mm	53 mm

*Para gatos/For cats

Placas híbridas panartrodesis carpal escalonadas
Stepped hybrid plates for carpal panarthrodesis

Ref.	Tornillo/Screw	Long. total	Long. A
AR35-35L	3,5 - 2,7 - 3,5 mm	162 mm	90 mm
AR35-27EL	3,5 - 2,7 - 2,7 mm	158 mm	86,5 mm
AR35-27E	3,5 - 2,7 - 2,7 mm	148 mm	76,5 mm
AR35-27LL	3,5 - 2,7 - 2,7 mm	129 mm	76,5 mm
AR35-27L	3,5 - 2,7 - 2,7 mm	120 mm	66,5 mm
AR35-27CL	3,5 - 2,7 - 2,7 mm	110 mm	57,5 mm
AR35-27C	3,5 - 2,7 - 2,7 mm	101 mm	47,5 mm
AR27-20L	2,7 - 2 - 2 mm	85 mm	46 mm
AR27-20	2,7 - 2 - 2 mm	76 mm	36 mm

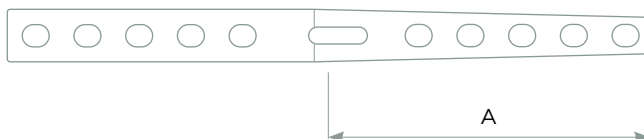

Placas bloqueadas de tornillos de cortical

Screw locked plates cortical

Placas bloqueadas rectas de bajo contacto

Low contact locking plates

Ref.	Tornillo Screw	Orificios Holes	Long.	Ancho Width	Grosor Thickness
PB1515E-020	Ø 1,5 mm	20	100 mm	4 mm	2/1,5 mm
PB1515A-020	Ø 1,5 mm	20	120 mm	4 mm	2/1,5 mm
PB2020-025	Ø 2 mm	25	150 mm	7 mm	2,5/2 mm
PB2424-020	Ø 2,4 mm	20	140 mm	7 mm	2,5 mm
PB2727-020	Ø 2,7 mm	20	140 mm	8 mm	3 mm
PB2727-025	Ø 2,7 mm	19	150 mm	7 mm	3/2,5 mm

Placa bloqueada de reconstrucción

Cut to length reconstruction locking

Ref.	Tornillo Screw	Orificios Holes	Long.	Ancho Width	Grosor Thickness
PB15RC-020	Ø 1,5 mm	20	100 mm	4 mm	2/1,5 mm
PB20RC-021	Ø 2 mm	30	150 mm	5 mm	2,5 mm
PB27RC-022	Ø 2,7 mm	25	150 mm	7 mm	3/2,5 mm
PB27RC-023	Ø 2,7 mm	24	192 mm	8 mm	3/2,5 mm
PB35RC-E22	Ø 3,5 mm	22	260 mm	10,2 mm	4/3,5 mm
PB35RC-A24	Ø 3,5 mm	22	260 mm	12 mm	4/3,5 mm
PB45RC-E25	Ø 4,5 mm	16	300 mm	14 mm	5.0/4.3 mm
PB45RC-A25	Ø 4,5 mm	16	300 mm	16 mm	5.0/4.3 mm

Placa bloqueada en T / Locking t plates

Ref.	Tornillo Screw	Long.	Ancho cabeza Head width	Ancho cola width plate shaft	Grosor Thickness
PBT-15	Ø 1,5 mm	26,5 mm	7 mm	4 mm	2 mm
PBT-20C	Ø 2 mm	28 mm	9 mm	5 mm	2,5 mm
PBT-20L	Ø 2 mm	35 mm	9 mm	5 mm	2,5 mm
PBT-27	Ø 2,7 mm	55 mm	13 mm	7 mm	3 mm
PBT-27C	Ø 2,7 mm	40 mm	16 mm	8 mm	3 mm
PBT-35	Ø 3,5 mm	80 mm	18 mm	11 mm	4 mm
PBT-35C	Ø 3,5 mm	55 mm	22 mm	10 mm	4 mm
PBT-35L	Ø 3,5 mm	80 mm	24 mm	12 mm	4 mm

Placas bloqueadas de tornillos de cortical

Screw locked plates cortical

Placas bloqueadas sostén / *Butress locking-plate*

Tornillo / Screw: Ø 1,5 mm
Ancho / Width: 4 mm
Grosor / Thickness: 2 mm

Ref.	Long.
PB1515-004	24 mm
PB1515-006	34 mm
PB1515-008	44 mm
PB1515-010	54 mm

Tornillo / Screw: Ø 2,4 mm
Ancho / Width: 7 mm
Grosor 2,5 mm

Ref.	Long.
PB2424-070	70 mm
PB2424-080	80 mm
PB2424-090	90 mm
PB2424-100	100 mm

Tornillo / Screw: Ø 3,5 mm
Ancho / Width: 10,2 mm
Grosor / Thickness: 4 mm

Ref.	Long.
PB3535E-100	100 mm
PB3535E-120	120 mm
PB3535E-140	140 mm
PB3535E-160	160 mm

Tornillo / Screw: Ø 3,5 mm
Ancho / Width: 12 mm
Grosor / Thickness: 4 mm

Ref.	Long.
PB3535A-100	100 mm
PB3535A-120	120 mm
PB3535A-140	140 mm
PB3535A-160	160 mm
PB3535A-180	180 mm

Tornillo / Screw: Ø 2 mm
Ancho / Width: 7 mm
Grosor / Thickness 2 mm

Ref.	Long.
PB2020-070	70 mm
PB2020-080	80 mm
PB2020-090	90 mm
PB2020-100	100 mm

Tornillo / Screw: Ø 2,7 mm
Ancho / Width: 8 mm
Grosor / Thickness 3 mm

Ref.	Long.
PB2727-070	70 mm
PB2727-080	80 mm
PB2727-090	90 mm
PB2727-100	100 mm
PB2727-110	110 mm
PB2727-120	120 mm
PB2727-130	130 mm

Tornillo / Screw: Ø 4,5 mm
Ancho / Width: 12 mm
Grosor / Thickness 5 mm

Ref.	Long.
PB4545-100	100 mm
PB4545-120	120 mm
PB4545-140	140 mm
PB4545-160	160 mm
PB4545-180	180 mm

Placas bloqueadas de tornillos de cortical

Screw locked plates cortical

Placas bloqueadas para la osteotomía craneal de la tibia (cuña) y otras aplicaciones / *Locking Plates for Cranial Tibia Osteotomy and Other Applications*

Placas cobra / Cobra plates

Ref.	Long.	Ancho cabeza <i>Head width</i>	Ancho cola <i>Width plate shaft</i>	Grosor <i>Thickness</i>	Tornillo <i>Screw</i>
PBCTWO-20	39 mm	10 mm	6 mm	2,5 mm	2 mm
PBCTWO-24	42,5 mm	12 mm	6,5 mm	2,5 mm	2,4 mm
PBCTWO-27C	48 mm	14 mm	8 mm	2,5 mm	2,7 mm
PBCTWO-27L	59 mm	16 mm	10 mm	2,5 mm	2,7 mm
PBCTWO-27G	66 mm	16 mm	10 mm	2,5 mm	2,7 mm
PBCTWO-3	67 mm	18 mm	12 mm	3 mm	3,5 mm
PBCTWO-4	79 mm	18 mm	12 mm	3 mm	3,5 mm
PBCTWO-5	92 mm	18 mm	12 mm	3 mm	3,5 mm
PBCTWO-4SF	78 mm	16 mm	12 mm	3 mm	3,5 mm

Placas bandera / Flag plates

Para tornillo / *For screw*: Ø 3,5 mm

Ref.	Bandera	Long.	Ancho cabeza <i>Head width</i>	Ancho cola <i>Width plate shaft</i>	Grosor <i>Thickness</i>
PBCTWO-D4	derecha	80 mm	24 mm	12 mm	3 mm
PBCTWO-I4	izquierda	80 mm	24 mm	12 mm	3 mm
PBCTWO-D5	derecha	92 mm	24 mm	12 mm	3 mm
PBCTWO-I5	izquierda	92 mm	24 mm	12 mm	3 mm
PBCTWO-DG	derecha	110 mm	28 mm	13 mm	4 mm
PBCTWO-IG	izquierda	110 mm	28 mm	13 mm	4 mm

Placas acetabulares / Acetabular plates

Ref.	Tornillo/ <i>Screw</i>
PBACET-020	Ø 2 mm
PBACET-027	Ø 2,7 mm
PBACET-035	Ø 3,5 mm

Placas bloqueadas de tornillos de cortical *Screw locked plates cortical*

Placas doble/triple osteotomía de cadera *Double/triple pelvic osteotomy plates*

Placa bloqueo doble

Izquierdo / *Left*

Ref.	Grados <i>Degrees</i>	Tornillo <i>Screw</i>
PBDPO-25I	25°	3,5 mm
PBDPO-35I	35°	3,5 mm

Derecha / *Right*

Ref.	Grados <i>Degrees</i>	Tornillo <i>Screw</i>
PBDPO-25D	25°	3,5 mm
PBDPO-35D	35°	3,5 mm

Placa síndrome compartimento medial del codo *Medial compartment disease plates*

Ref.	Long. total	Paso <i>Step</i>	Tornillo <i>Screw</i>
PBMCD-02	70 mm	2,5 mm	3,5 mm

Placas de bloqueo panartrodesis carpal escalonadas *Stepped hybrid locking plates for carpal panarthrodesis*

Ref.	Tornillo <i>Screw</i>	Long. total	Long. A
PBAR35-35L	3,5 - 2,7 mm	162 mm	90 mm
PBAR35 - 27EL	3,5 - 2,7 - 2 mm	158 mm	86,5 mm
PBAR35 - 27E	3,5 - 2,7 - 2 mm	148 mm	76,5 mm
PBAR35 - 27LL	3,5 - 2,7 - 2 mm	129 mm	76,5 mm
PBAR35 - 27L	3,5 - 2,7 - 2 mm	120 mm	66,5 mm
PBAR35 - 27CL	3,5 - 2,7 - 2 mm	110 mm	57,5 mm
PBAR35 - 27C	3,5 - 2,7 - 2. mm	101 mm	47,5 mm
PBAR27 - 20L	2,7 - 2 - 1,5 mm	85 mm	46 mm
PBAR27 - 20	2,7 - 2 - 1,5 mm	76 mm	36 mm

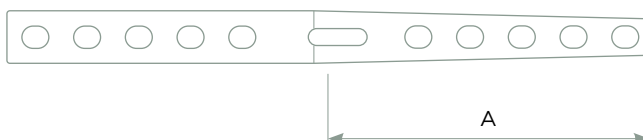



Placas rectas cortables
Cuttable straight plates



Placas de bloqueo tornillos cónicos

Locking screws

Placas rectas cortables / *Cuttable straight plates*

Para tornillos: Ø 1,5 mm

Ref.	Ancho	Orificios/Holes
LP15-020	4 mm	20
LP15-021	5 mm	20

Para tornillos: Ø 2 mm

Ref.	Ancho	Orificios/Holes
LP20-021	5 mm	30
LP20-025	7,5 mm	25

Para tornillos: Ø 2,4 mm

Ref.	Ancho	Orificios/Holes
LP24-020	6 mm	20

Para tornillos: Ø 2,7 mm

Ref.	Ancho	Orificios/Holes
LP27-020	8	15
LP27-022	7	25
LP27-023	8	22
LP27-025	7,5	25

Para tornillos: Ø 3,5 mm

Ref.	Ancho	Orificios/Holes
LP35-E22	10 mm	22
LP35-A22	12 mm	22



Tornillos de bloqueo
Locking screws



Placas de bloqueo tornillos cónicos / Locking screws

Tornillos de bloqueo / Locking screws

Ø 1,5 mm

Ref.	Long.
TB15-006	6 mm
TB15-007	7 mm
TB15-008	8 mm
TB15-009	9 mm
TB15-010	10 mm
TB15-011	11 mm
TB15-012	12 mm
TB15-014	14 mm
TB15-016	16 mm
TB15-018	18 mm
TB15-020	20 mm

Ø 2 mm

Ref.	Long.
TB20-006	6
TB20-008	8
TB20-010	10
TB20-012	12
TB20-014	14
TB20-016	16
TB20-018	18
TB20-020	20
TB20-022	22
TB20-024	24
TB20-026	26
TB20-028	28
TB20-030	30

Ø 2,4 mm

Ref.	Long.
TB24-006	6
TB24-008	8
TB24-010	10
TB24-012	12
TB24-014	14
TB24-016	16
TB24-018	18
TB24-020	20
TB24-022	22
TB24-024	24
TB24-026	26
TB24-028	28
TB24-030	30

Ø 2,7 mm

Ref.	Long.
TB27-006	6
TB27-008	8
TB27-010	10
TB27-012	12
TB27-014	14
TB27-016	16
TB27-018	18
TB27-020	20
TB27-022	22
TB27-024	24
TB27-026	26
TB27-028	28
TB27-030	30
TB27-032	32
TB27-034	34

Ø 3,5 mm

Ref.	Long.
TB35-010	10
TB35-012	12
TB35-014	14
TB35-016	16
TB35-018	18
TB35-020	20
TB35-022	22
TB35-024	24
TB35-026	26
TB35-028	28
TB35-030	30
TB35-032	32
TB35-034	34
TB35-036	36
TB35-038	38
TB35-040	40
TB35-045	45
TB35-050	50
TB35-055	55
TB35-060	60



Placas multiples orificios
Multiple hole plates



Placas de bloqueo tornillos cónicos / Locking screws

Placas multiples orificios / Multiple hole plates

Para tornillo / For screw: Ø 1,5 mm

Ref.	Nº orif.	Long.
LP15-004	4	27,5
LP15-005	5	34,5
LP15-006	6	41,5
LP15-007	7	48,5
LP15-008	8	55,5
LP15-009	9	62,5
LP10-010	10	69,5

Para tornillo / For screw: Ø 2 mm

Ref.	Nº orif.	Long.
LP20-004	4	27,5
LP20-005	5	34,5
LP20-006	6	41,5
LP20-007	7	48,5
LP20-008	8	55,5
LP20-009	9	62,5
LP20-010	10	69,5
LP20-012	12	83,5
LP20-014	14	91,5

Para tornillo / For screw: Ø 2,4 mm

Ref.	Nº orif.	Long.
LP24-004	4	32
LP24-005	5	40
LP24-006	6	48
LP24-007	7	56
LP24-008	8	64
LP24-009	9	72
LP24-010	10	80
LP24-012	12	96
LP24-014	14	108

Para tornillo / For screw: Ø 2,7 mm

Ref.	Nº orif.	Long.
LP27-004	4	36
LP27-005	5	45
LP27-006	6	54
LP27-007	7	63
LP27-008	8	72
LP27-009	9	81
LP27-010	10	90
LP27-012	12	108
LP27-014	14	126

Para tornillo / For screw: 3,5 mm
Ancho / Width: 10,2 mm

Ref.	Nº orif.	Long.
LP35E-004	4	54
LP35E-005	5	67
LP35E-006	6	80
LP35E-007	7	93
LP35E-008	8	106
LP35E-009	9	119
LP35E-010	10	132
LP35E-011	11	145
LP35E-012	12	157
LP35E-013	13	170
LP35E-014	14	183

Para tornillo / For screw: 3,5 mm
Ancho / Width: 12 mm

Ref.	Nº orif.	Long.
LP35A-004	4	54
LP35A-005	5	67
LP35A-006	6	80
LP35A-007	7	93
LP35A-008	8	106
LP35A-009	9	119
LP35A-010	10	132
LP35A-011	11	145
LP35A-012	12	157
LP35A-013	13	170
LP35A-014	14	183



Placas de sosten
Support plates



Placas enfermedad
compartimento



Placas acetabulares
Acetabular plates



Placas de bloqueo tornillos cónicos / *Locking screws*

Placas de sostén / *Support plates*

Para tornillo/*For screw:*
Ø 1,5 mm

Ref.	Long.
LP15-024	24 mm
LP15-034	34 mm
LP15-044	44 mm
LP15-054	54 mm

Para tornillo/*For screw:*
Ø 2 mm

Ref.	Long.
LP20-070	70 mm
LP20-080	80 mm
LP20-090	90 mm
LP20-100	100 mm

Para tornillo/*For screw:*
Ø 2,4 mm

Ref.	Long.
LP24-070	70
LP24-080	80
LP24-090	90
LP24-100	100

Para tornillo/*For screw:*
Ø 2,7 mm

Ref.	Long.
LP27-070	70
LP27-080	80
LP27-090	90
LP27-100	100
LP27-110	110
LP27-120	120
LP27-130	130

Para tornillo/*For screw:*
3,5 mm estrechas
Ancho / *Width:* 10,2 mm

Ref.	Long.
LP35E-100	100
LP35E-120	120
LP35E-140	140
LP35E-160	160

Para tornillo/*For screw:*
3,5 mm estrechas
Ancho / *Width:* 12 mm

Ref.	Long.
LP35A-100	100
LP35A-120	120
LP35A-140	140
LP35A-160	160
LP35A-180	180

Placas síndrome compartimento medial del codo / *Plates for medial elbow compartment disease*

Ref.	Tornillo/ <i>Screw</i>
LPMCD-35	Placas tornillos 3,5 mm

Placas acetabulares / *Acetabular plates*

Ref.	Tornillo/ <i>Screw</i>
LPACET-20	Placas tornillos 2,0
LPACET-27	Placas tornillos 2,7
LPACET-35	Placas tornillos 3,5



Cabeza de 2 orificios
2 hole head



Cabeza de 3 orificios
3 hole head



Forma de trébol
Clover shape



Placas de bloqueo tornillos cónicos / Locking screws

Placas en T / T plates

Cabeza de 2 orificios / 2 hole head

Ref.	Ancho cabeza <i>Head thickness</i>	Long.	Tornillo <i>Screw</i>
LPT-15-2	7 mm	27 mm	1,5 mm
LPT-20-C-2	9 mm	28 mm	2 mm
LPT-20L-2	9 mm	35 mm	2 mm
LPT-24-2	11 mm	45 mm	2,4 mm
LPT-27-2	13 mm	55 mm	2,7 mm
LPT-35-2	16 mm	80 mm	3,5 mm

Cabeza de 3 orificios / 3 hole head

Ref.	Ancho cabeza <i>Head thickness</i>	Long.	Tornillo <i>Screw</i>
LPT-15-3	7 mm	27 mm	1,5 mm
LPT-20-C-3	9 mm	28 mm	2 mm
LPT-20L-3	9 mm	35 mm	2 mm
LPT-24-3	11 mm	45 mm	2,4 mm
LPT-27-3	13 mm	55 mm	2,7 mm
LPT-35-3	16 mm	80 mm	3,5 mm

Forma de trébol / Clover shape

Ref.	Ancho cabeza <i>Head thickness</i>	Long.	Tornillo <i>Screw</i>
LPT-27C	16 mm	40 mm	2,7 mm
LPT-35C	22 mm	55 mm	3,5 mm
LPT-35L	24 mm	80 mm	3,5 mm



Placas cobra
Cobra plates



Placas bandera
Flag plates



Placas de bloqueo tornillos cónicos / Locking screws

Placas CTWO (cobras y banderas)

CTWO plates (cobra and flags)

Placas cobra / Cobra plates

Ref.	Ancho cabeza Head width	Long.	Tornillo/Screw
LPCTWO-20	10 mm	39 mm	2 mm
LPCTWO-24	12 mm	42,5 mm	2,4 mm
LPCTWO-27C	13,5 mm	48 mm	2,7 mm
LPCTWO-27L	15,5 mm	59 mm	2,7 mm
LPCTWO-27G	17 mm	66 mm	2,7 mm

Ref.	Cabeza/Head		Long.	Tornillo/Screw
	Ancho/ Width	Alto/ Height		
LPCTWO35-3	18 mm	25 mm	67 mm	3,5 mm
LPCTWO35-4	18 mm	25 mm	79 mm	3,5 mm
LPCTWO35-5	18 mm	25 mm	92 mm	3,5 mm
LPCTWO35-4SF	18 mm	16 mm	79 mm	3,5 mm

Placas bandera / Flag plates

Ref.	Ancho cabeza Head width	Bandera/Flag	Long.	Tornillo/Screw
LPCTWO35-4D	24,5 mm	Derecha	80 mm	3,5 mm
LPCTWO35-4I	24,5 mm	Izquierda	80 mm	3,5 mm
LPCTWO35-5D	24,5 mm	Derecha	92 mm	3,5 mm
LPCTWO35-5I	24,5 mm	Izquierda	92 mm	3,5 mm
LPCTWO35-DG	28 mm	Derecha	110 mm	3,5 mm
LPCTWO35-IG	28 mm	Izquierda	110 mm	3,5 mm



Placas en forma de stick
Stick-shaped plates



Placas en forma palo de golf
Golf club shaped plates



Placas panartrodesis carpal
escalonadas

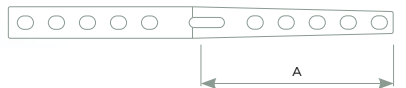

Placas de bloqueo tornillos cónicos / *Locking screws*

Placas supracondilares de fémur

Supracondylar plates of fémur

Placas en forma de stick / *Stick-shaped plates*

Ref.	Long.	Tornillo/Screw
LP20-SD	60 mm	2 mm
LP20-SI	60 mm	2 mm

Placas en forma palo de golf / *Golf club shaped plates*

Ref.	Long.	Tornillo/Screw
LP20-FED	51 mm	2 mm
LP20-FEI	51 mm	2 mm
LP24-FED	50 mm	2,4 mm
LP24-FEI	50 mm	2,4 mm
LP27-FED	71 mm	2,7 mm
LP27-FEI	71 mm	2,7 mm
LP35-FED	100 mm	3,5 mm
LP35-FEI	100 mm	3,5 mm

Placas panartrodesis carpal escalonadas

Staggered carpal panarthrodesis plates

Ref.	Tornillo/Screw	Long. A	Long. total
LPAR27-020	2,7-2 mm	35 mm	76 mm
LPAR27-020L	2,7-2 mm	45 mm	86 mm
LPAR35-27C	3,5-2,7 mm	47 mm	101 mm
LPAR35-27CL	3,5-2,7 mm	57 mm	110 mm
LPAR35-27L	3,5-2,7 mm	66 mm	120 mm
LPAR35-27LL	3,5-2,7 mm	76 mm	129 mm
LPAR35-27E	3,5-2,7 mm	76 mm	148 mm
LPAR35-27EL	3,5-2,7 mm	87 mm	158 mm



Recta
Straight



Curvadas
Curved



INSORVET

Placas de bloqueo tornillos cónicos / Locking screws

Placas TPLO / TPLO plate

Rectas / Straight

Ref.	Tornillo/Screw	Long.
LPTPLOR-20D	2 mm	30 mm
LPTPLOR-20I	2 mm	30 mm
LPTPLOR-24D	2,4 mm	35 mm
LPTPLOR-24I	2,4 mm	35 mm
LPTPLOR-27D	2,7 mm	46 mm
LPTPLOR-27I	2,7 mm	46 mm
LPTPLORS-35D	3,5 mm	55 (small)
LPTPLORS-35I	3,5 mm	55 (small)
LPTPLORM-35D	3,5 mm	64 (medium)
LPTPLORM-35I	3,5 mm	64 (medium)
LPTPLORL-35D	3,5 mm	80 (large)
LPTPLORL-35I	3,5 mm	80 (large)

Curvas / Curved

Ref.	Tornillo/Screw	Long.
LPTPLOC-20D	2 mm	30 mm
LPTPLOC-20I	2 mm	30 mm
LPTPLOC-24D	2,4 mm	35 mm
LPTPLOC-24I	2,4 mm	35 mm
LPTPLOC-27D	2,7 mm	46 mm
LPTPLOC-27I	2,7 mm	46 mm
LPTPLOCS-35D	3,5 mm	55 (small)
LPTPLOCS-35I	3,5 mm	55 (small)
LPTPLOCM-35D	3,5 mm	64 (medium)
LPTPLOCM-35I	3,5 mm	64 (medium)
LPTPLOCL-35D	3,5 mm	80 (large)
LPTPLOCL-35I	3,5 mm	80 (large)



Placas panartrodesis tarsal
Tarsal panarthrodesis plates



Placas panartrodesis tarsal

Tarsal panarthrodesis plates

Ref.	Tornillo/ <i>Screw</i>	Long. A	Long. B
LPT20-015D	2 - 1,5 mm	32 mm	32 mm
LPT20-015I	2 - 1,5 mm	32 mm	32 mm
LPT24-020D	2,4 - 2 mm	35 mm	35 mm
LPT24-020I	2,4 - 2 mm	35 mm	35 mm
LPT27-020D	2,7 - 2 mm	39 mm	39 mm
LPT27-020I	2,7 - 2 mm	39 mm	39 mm
LPT35-027D	3,5 - 2,7 mm	57 mm	57 mm
LPT35-027I	3,5 - 2,7 mm	57 mm	57 mm
LPT35L-027D	3,5 - 2,7 mm	74 mm	74 mm
LPT35L-027I	3,5 - 2,7 mm	74 mm	74 mm
LPT35-035D	3,5 - 3,5 mm	74 mm	74 mm
LPT35-035L	3,5 - 3,5 mm	74 mm	74 mm



Instrumental y otros implantes
Instrumental and other implants

INSORVET

Clavos cerrojados / *Interlocking nails*

Orificios continuos / *Multiple holes*



Ref.	Long.	Tornillos / Screw
2504-020	4 mm	2 mm
2505-027	5 mm	2,7 mm
2506-027	6 mm	2,7 mm
2507-035	7 mm	3,5 mm
2508-035	8 mm	3,5 mm
2509-035	9 mm	3,5 mm
2510-045	10 mm	4,5 mm

Guía externa / *External guide*

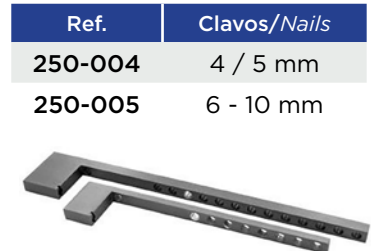

Ref.	Clavos/Nails
250-004	4 / 5 mm
250-005	6 - 10 mm

Orificios discontinuos / *Four-holes*



Ref.	Long.	Agujeros	Tornillos Screw
2514-110	110	4+5	2 mm
2514-125	125	5+6	2 mm
2514-140	140	6+7	2 mm
2515-125	125	5+6	2,7 mm
2515-140	140	6+7	2,7 mm
2515-155	155	7+8	2,7 mm
2515-125	125	6+7	2,7 mm
2515-140	140	7+8	2,7 mm
2515-155	155	8+9	2,7 mm
2516-140	140	9+10	2,7 mm
2516-155	155	7+8	2,7 mm
2516-170	170	8+9	2,7 mm
2516-185	185	9+10	2,7 mm

Ref.	Long.	Agujeros	Tornillos Screw
2517-155	155	7+8	3,5 mm
2517-170	170	8+9	3,5 mm
2517-185	185	9+10	3,5 mm
2517-200	200	10+11	3,5 mm
2518-170	170	8+9	3,5 mm
2518-185	185	9+10	3,5 mm
2518-200	200	10+11	3,5 mm
2518-215	215	11+12	3,5 mm
2519-170	170	8+9	4,5 mm
2519-185	185	9+10	4,5 mm
2519-200	200	10+11	4,5 mm
2519-215	215	11+12	4,5 mm
2519-230	230	12+13	4,5 mm

Steinmann

Ref.	Ø	Long.
0440-250	4 mm	250 mm
0450-250	5 mm	250 mm
0460-250	6 mm	250 mm
0470-250	7 mm	250 mm
0480-250	8 mm	250 mm
0490-250	9 mm	250 mm
0410-250	10 mm	250 mm



Rótulas simples / *Single connecting bars clamps*

Ref.	Ø
2512-015	1,2 x 1,5 mm
2515-020	1,5 x 2 mm
2520-030	2 x 3 mm
2520-040	2 x 4 mm
2525-040	2,5 x 4 mm
2530-040	3 x 4 mm



Rótulas dobles / *Double connecting bars clamps*

Ref.	Ø
2512-015D	1,2 x 1,5 mm
2515-020D	1,5 x 2 mm
2520-030D	2 x 3 mm
2520-040D	2 x 4 mm
2525-040D	2,5 x 4 mm
2530-040D	3 x 4 mm



Barras conectoras *Connecting bars length (280 mmm)*

Ref.	Ø
2500-228	2 mm
2500-328	3 mm
2500-428	4 mm

Elongador de hueso cuadrado
Squared bone lengthening

Ref.
EL-C



Agujas / Needle

Rosca positiva en punta
Positive thread on tip

Ref.	Ø	Long. rosca <i>Long. thread</i>
RP12-008	1,2 mm	8
RP15-008	1,5 mm	8
RP15-015	1,5 mm	15
RP20-015	2 mm	15
RP20-020	2 mm	20
RP25-015	2,5 mm	15
RP25-025	2,5 mm	25
RP30-020	3 mm	20
RP30-030	3 mm	30
RP40-020	4 mm	20
RP40-030	4 mm	30

Rosca positiva en el centro
Positive thread in the center

Ref.	Ø	Long. rosca <i>Long. thread</i>
RC12-008	1,2 mm	8
RC15-008	1,5 mm	8
RC15-015	1,5 mm	15
RC20-010	2 mm	10
RC20-020	2 mm	20
RC25-020	2,5 mm	20
RC25-030	2,5 mm	30
RC30-020	3 mm	20
RC30-030	3 mm	30
RC40-020	4 mm	20
RC40-030	4 mm	30



Kirschner de dos puntas trocar / *Two trocar points*

Ref.	Ø	Long.
K-0.8	0,8 mm	285 mm
K-10	1 mm	285 mm
K-12	1,2 mm	285 mm
K-15	1,5 mm	285 mm
K-18	1,8 mm	285 mm
K-20	2 mm	285 mm
K-25	2,5 mm	285 mm
K-30	3 mm	285 mm

Arpones / *Harpoon*

Ref.	Ø	Long.
AC25-010	2,5 mm	10 mm
AC25-015	2,5 mm	15 mm
AC30-015	3 mm	15 mm
AC30-020	3 mm	20 mm
AC30-025	3 mm	25 mm
AC40-020	4 mm	15 mm
AC40-025	4 mm	25 mm
AC40-030	4 mm	25 mm



Brocas / *Drill*

Lisas / *Bits*

Ref.	Ø	Long.
B-11	1,1 mm	60 mm
B-15	1,5 mm	90 mm
B-18	1,8 mm	100 mm
B-20	2 mm	100 mm
B-25	2,5 mm	130 mm
B-27	2,7 mm	130 mm
B-28	2,8 mm	130 mm
B-32	3,2 mm	130 mm
B-35	3,5 mm	130 mm
B-45	4,5 mm	130 mm



De Anclaje rápido / *Quick fit*

Ref.	Ø	Long.
BA-11	1,1 mm	60 mm
BA-15	1,5 mm	85 mm
BA-20	2 mm	100 mm
BA-25	2,5 mm	110 mm
BA-27	2,7 mm	100 mm
BA-32	3,2 mm	145 mm
BA-35	3,5 mm	110 mm
BA-45	4,5 mm	145 mm



Guías de broca / *Drill guides*

Ref.	Brocas <i>Drill</i>	Placa <i>Plate</i>	Tornillos <i>Screw</i>
GBTC-15	1,1 mm	Placas LP	1,5 mm
GBTC-20	1,5 mm	Placas LP	2 mm
GBTC-24	1,8 mm	Placas LP	2,4 mm
GBTC-27	2 mm	Placas LP	2,7 mm
GBTC-35	2,8 mm	Placas LP	3,5 mm



Rollos cerclajes
Rolls of soft wire

Ref.	Ø	Long.
0407-008	0,8 mm	10 m
0407-010	1 mm	10 m
0407-012	1,2 mm	10 m
0407-015	1,5 mm	10 m



Retradores de Kishigamy
Kishigamy retractor

Ref.	Asas / Hooks
KS-3H	3
KM-3H	3
KL-3H	3
KS-4H	4
KM-4H	4
KL-4H	4

3 Asas / Hooks



4 Asas / Hooks



Atornillador / *Screwdriver*

Con mango / *with handle*

Ref.	Tornillos / Screw	Pinza / Forceps
AT-15M	1,5-2 mm	No
AT-15MP	1,5-2 mm	Sí
AT-27M	2,7-3,5 mm	No
AT-27MP	2,7-3,5 mm	Sí
AT-45M	4,5-6,5 mm	No
AT-45MP	4,5-6,5 mm	Sí



Anclaje rápido / *Quick fit*

Ref.	Tornillos / Screw	Pinza / Forceps
AT-15	1,5-2 mm	No
AT-15P	1,5-2 mm	Sí
AT-27	2,7-3,5 mm	No
AT-27P	2,7-3,5 mm	Sí
AT-45	4,5-6,5 mm	No



Torx con Anclaje rápido / *Quick fit*

Ref.	Tornillos / <i>Screw</i>
TX-4	1,5 mm
TX-6	2 mm
TX-8	2,4/2,7 mm
TX-15	3,5 mm

Mango Anclaje rápido
Quick fit / Strait handle with quick fit

Ref.
MAR-R



Pasamachos / *Tap*

Anclaje rápido / *Quick fit*

Ref.	Tornillos / <i>Screw</i>
PM-15	1,5 mm
PM-20	2 mm
PM-27	2,7 mm
PM-35	3,5 mm
PM-40	4 mm
PM-45	4,5 mm



En T

Ref.	Tornillos / <i>Screw</i>
PM-15T	1,5 mm
PM-20T	2 mm
PM-27T	2,7 mm
PM-35T	3,5 mm
PM-40T	4 mm



Extractor de Tornillos / Screw

Ref.	Ø
ET-1520	1,5-2 mm
ET-2735	2,7-3,5 mm
ET-45	4,5 mm



Fresas / Drills

Ref.	Ø
F-1	1 mm
F-2	2 mm
F-3	3 mm
F-4	4 mm
F-5	5 mm
F-6	6 mm



Arandelas / Washers

Ref.	Ø	Tornillos / Screw
A-45	4,5 mm	2 mm
A-7	7 mm	2,7/3,5/4 mm
A-10	10 mm	2,7/3,5/4 mm
A-13	13 mm	4,5 mm
A-19	19 mm	4,5 mm



Casquillos sujeta nylon / *Nylon retaining caps*

Ref.	Forma
CAS-NYP	Plano / <i>Plane</i>
CAS-NYR	Redondo / <i>Round</i>



Meniscotom / *Meniscotomo*

Ref.	
7750-001	Smille
7750-002	Smille
7750-036	Birscher
7750-021	Smith
7750-022	Smith
7750-023	Smith



Osteotomo / *Bone chisel*

Ref.	Corte	Long.
2804-004	4 mm	14 cm
2820-005	5 mm	14 cm
2804-006	6 mm	14 cm
2804-008	8 mm	14 cm
2804-010	10 mm	14 cm
2804-012	12 mm	14 cm
2820-018	18 mm	16 cm



Cucharilla Volkmann doble / *Double Volkmann spoon*

Ref.	Ø
2951-025	2x3
2951-027	6x7



Mango hojas osteotomo / *Chisel Handle*

Ref.
SP-771

Hoja osteótomo / *Blade chisel*

Ref.	
SP-770	5 mm
SP-771	10 mm
SP-772	16 mm
SP-773	25 mm

Llave / *Wrench*

Ref.
SP-97

Gúbia recta / *Ruskin rongeurs*

Ref.	Ø	Long.
3104-002	2 mm	15 cm
3105-002	2 mm	15 cm
3105-004	4 mm	15 cm
3105-005	5 mm	15 cm



Instrumental y otros implantes *Instrumental and other implants*

Pinzas Kern / *Kern bone holding forceps*

Ref.	Ø
0380-015	15 mm
0380-017	17 mm
0380-021	21 mm



Hohmann retractor

Ref.	Ø
HOH-06	6 mm
HOH-08	8 mm
HOH-18	18 mm



Pinza sujeción hueso / *Reduction forceps with serrated jaw with speed lock*

Ref.	Long.
0623-005	220 mm
0623-006	160 mm



Distractor rodilla / *Knee distractor*

Ref.	Long.
4040-517	17 cm



Pinzas Verbrugge / *Forceps Verbrugge*

Ref.	Long.
716-22	150 mm
716-23	190 mm
716-24	260 mm



Pinzas Heiss / *Heiss vascular clamp*

Ref.
1651-090



1651-090

Pinzas Babcock / *Forceps Babcock*

Ref.
5010-016



5010-016

Pinzas Ruskin Corta Hueso
Ruskin bone cutting forceps

Ref.	Long.
27-3850	18 cm



27-3850

Alicates Liston Corta Hueso
Liston bone cutting forceps

Ref.	Long.
22-2291	12,5 cm



22-2291

Pinzas para tejidos Allis
Allis tissue seizing forceps

Ref.	Long.
22-2257	16 cm



22-2257

Pinzas hemostáticas Mosquito
Mosquito hemostatic forceps

Ref.	Long.	
15-162	12,5 cm	Recta / <i>Straight</i>
439	12,5 cm	Curva / <i>Curved</i>



15-162



439

Instrumental y otros implantes

Instrumental and other implants

Pinzas hemostáticas Kocher dentadas recta
Kocher hemostatic straight forceps

Ref.
17-136



Separador Weitlaner con punta roma
Weitlaner retractor

Ref.	Long.
WET-001	11 cm
WET-002	13 cm
WET-003	16 cm
WET-004	19 cm

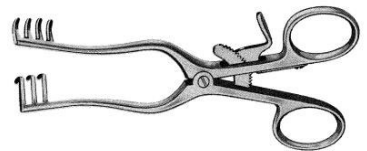

Pinzas laminectomía
Laminectomy cutting forceps

Ref.	Long.	Angulo
LAM20-R	2 mm	
LAM20-40	2 mm	40°
LAM30-R	3 mm	
LAM20-40	3 mm	40°
LAM40-R	4 mm	
LAM40-40	4 mm	40°

Cizalla corte clavos
Rod cutter

Ref.	Long.	Corte
CZ-30	30 cm	3 mm
CZ-40	40 cm	4 mm



Alicate de corte / *Wire-cutter*

Ref.	Long.
SP- 1616	24 cm
7645-045	23 cm
7645-050	14 cm



SP- 1616



7645-045



7645-050

Alicate corte puntas de tungsteno
Wire-cutter tungsten point

Ref.	Long.	Corte
AL-TG	23 cm	Recto
AL-TGI	23 cm	Inclinado / <i>inclined</i>



AL-TG



AL-TGI

Alicate Hércules hojas
intercambiables
Wire-cutter tungsten point

Ref.
HER-001



HER-001

Alicate bloqueo / *Locking pliers*

Ref.	Long.
0607-089	23 cm



0607-089

Alicate doblado placas pequeñas
Universal bending pliers

Ref.
3901-010



3901-010

Instrumental y otros implantes Instrumental and other implants

Porta-agujas / Needle holder

Ref.	Tipo	Long.
22-2253-16	Guillies	16 cm
22-2227	Webster	13 cm



22-2253-16

22-2227

Pinzas / Forceps

Ref.	Tipo	Long.
22-2018	Wangensteen	15 cm
22-2014	Chir. Pinzette	16 cm
0463-097	Sujeción Tornillos / Screw	



Tijeras / Scissors

Ref.	Tipo	Long.
22-2276	Mayo-Stillle curva	15 cm
22-2269	Lister curva	18 cm
22-2281	Metzemabaum curva	18 cm
22-2285	Metzemabaum recta	18 cm
22-2289-01	Irisschere	11,5 cm
11-141	Spencer	13 cm



22-2276

22-2269

22-2281

22-2285

22-2289-01

11-141

Raspa para huesos Putti / *Putti bone rasp*

Ref.	Long.
27-3654	27 cm
27-3653	30 cm



Separador / *Retractor*

Ref.	Tipo	Profundidad	Separación
5422-051	Finochieto	18 mm	90 mm
5422-065	Finochieto	31 mm	100 mm
2455-002	Gosset		



Trefina de Michele / *Michele trephine*

Ref.	Ø
5763-005	5 mm
5763-008	8 mm



Sierra de Gigli / *Gigli saw*

Ref.	Ø
5764-030	30 cm
5764-040	40 cm
5764-002	Mango



Instrumental y otros implantes *Instrumental and other implants*

Impactador de grapas / *H. Ros impactor driver*

Ref.

1630-000



Extractor de grapas / *H. Ros staples elevator*

Ref.

1635-000



Portabrocas inoxidable
Stainless steel drill

Ref.

∅

0445-075

Hasta/until 6 mm



Pasahilo grande ojal en ambas puntas
Big Cable passer

Ref.

724-02



Grifas / *Bending iron*

Ref.

SP-237



Medidor de agujas, brocas y tornillos / *Screw / Gauge for drill bits, Kirchner wires and screws*

Ref.

Med-000



Grapas de epifisis / *Epyphysis staples*

Ref.	Ancho Width	Altura Height	Grosor Máx. Max. Thickness
1670-135	10 mm	22 mm	5 mm
1670-213	16 mm	22 mm	5 mm
1670-264	22 mm	22 mm	5 mm
1670-310	28 mm	22 mm	5 mm



Guías de broca dentadas / *Double drill sleeve*

Ref.	Ø
GD-1115	1,1 - 1,5 mm
GD-2027	2 - 2,7 mm
GD-2535	2,5 - 3,5 mm
GD-3245	3,2 - 4,5 mm
GD-3265	3,2 - 6,5 mm



Guía para controlar desviaciones en las osteotomías *Jig to avoid deviations in osteotomies*

Ref.
G-0



Periostotomos / *Periosteal elevator*

Ref.	Tipo	Long. de hoja	Long.
PL-000	Langenbeck	17 mm	19 cm
PS-000	Sedillot	13,5 mm	21 cm
H-000	Hyllin	9 mm	14,5 cm
J-000	Jansen	12 mm	17 cm



Langenbeck Sedillot Hyllin Jansen

Instrumental y otros implantes *Instrumental and other implants*

Separadores / *Separators*

Ref.
S-1
S-2
S-3
S-4
S-5
S-6



Caja de tornillos / *Screws box*

Ref.
CT-P







 **INSORVET**
Instrumental Ortopedia Veterinaria

INSORVET S.L.
C/ Rubio i Ors, 35
Pol. Ind. del Terri
17834 Porqueres (Girona) - España
680 876 043
info@insorvet.com

www.insorvet.com

