



Síndrome del compartimento medial



Cuñas de titanio poroso



Placa bloqueo escalonada
panartrodesis carpal

INSORVET SL

Cardedeu 1 - 08023 Barcelona, Spain

Tel: (34) 93 2844690

Móvil: 657226006

e-mail: info@insorvet.com

web: www.insorvet.com



Querido amigo y compañero/a,

Insorvet, nació en 1996 con la intención de desarrollar nuevos implantes e instrumental que nos permitiese mejorar el tratamiento de los problemas ortopédicos y de traumatología de pequeños animales a los que nos enfrentamos en nuestra práctica clínica.

Queremos destacar en este nuevo catálogo muchas innovaciones fruto de nuestra investigación como son los nuevos modelos de placas escalonadas de panartrodesis carpal, los nuevos modelos de TTA's etc. pero sobre todo, las placas de bloqueo cuyos precios es uno de sus atractivos ya que además, utilizan tornillos de cortical convencionales evitando la necesidad de adquirir costosos "tornillos especiales".

Gracias por confiar en nuestros productos, en nuestra innovación, investigación y mejora de los actuales implantes empleados en la traumatología y ortopedia de pequeños animales

Dear friend and colleague,

Insorvet was founded in 1996 with the objective of developing new implants and instruments to allow for the improvement of the treatment of the orthopaedic and traumatology problems observed in our veterinary practice.

We highlight in this new catalog many innovations as a result of our research as the new models of stepped pancarpal panarthrodesis plates, the new TTA's models etc. but above all, the locking plates whose prices is one of its attractions and also the fact, that conventional cortical screws are used with these plates avoiding the need to purchase expensive "special screws".

Thank you for trusting in our products, in our innovation, research and improvement of the current implants used in traumatology and orthopaedics of small animals.

Placas, tornillos e instrumental 1.5mm. <i>Plates 1.5mm cortical screws and instrumentation</i>	6-7
Placas bloqueadas 1.5mm. <i>Locking Plates 1.5mm</i>	8
Placas, tornillos e instrumental 2.0mm. <i>Plates 2.0mm cortical screws and instrumentation</i>	9-11
Placas bloqueadas 2.0mm. <i>Locking Plates 2.0mm</i>	12-13
Placas y tornillos 2.4mm. <i>2.4mm Plates and screws</i>	14
Placas bloqueadas 2.4mm. <i>2.4mm Plates Locking Plates</i>	15
Placas, tornillos e instrumental 2.7mm. <i>2.7mm Plates, cortical screws and instrumentation</i>	16-19
Casquillos guía Drill guides	19
Placas bloqueadas 2.7mm. <i>Locking Plates 2.7mm</i>	20-22
Placas, tornillos e instrumental 3.5mm. <i>Plates for 3.5 mm cortical screws and instrumentation</i>	23-26
Arandelas. Washers	27
Placas bloqueadas 3.5mm. <i>Locking Plates 3.5mm</i>	28-31
Placas, tornillos e instrumental 4.5mm. <i>Plates for 4.5mm cortical screws and instrumentation</i>	32-35
Placas bloqueadas 4.5mm. <i>Locking Plates 4.5mm</i>	36
Placas triple osteotomía cadera normales y bloqueadas. Placas síndrome compartimento medial del codo <i>Conventional and locking triple pelvic osteotomy plates Plates for medial elbow compartment disease</i> .	37
Placas híbridas de panartrodesis de tarso. <i>Hybrid plates for tarsal panarthrodesis</i>	38
Rotura ligamento cruzado anterior. <i>Anterior crucied ligament deficiency</i> .	
- Placas para la ostectomía en cuña craneal de la tibia. <i>Cranial tibial wedge ostectomy plates</i>	39-40
- Placas bloqueadas para la ostectomía en cuña craneal de la tibia. <i>Locking Cranial tibial wedge ostectomy plates</i>	41
- Técnica extracapsular. <i>Extracapsular techniques</i>	42
- Instrumental y cuñas de titanio poroso <i>Instrumentation and porous cages for TTA</i>	43
- Placas y cajas para el avance tuberosidad tibial. <i>Plates and cages for TTA</i>	44-46
Tornillos de titanio <i>Titanium screws</i>	47
Placa de panartrodesis carpal híbrida rectas y escalonada <i>Straight and stepped hybrid carpal panarthodesis plates</i>	48-49
Placa bloqueadas de panartrodesis carpal híbrida escalonada <i>Locking stepped hybrid carpal panarthodesis plates</i>	50-51
Placas en T convencionales y bloqueadas. <i>Conventional and locking T plates</i>	52
Placas acetabulares convencionales y bloqueadas. <i>Conventional and locking acetabular plates</i>	54
Placas condilares femorales y bloqueadas. <i>Conventional and locking femoral condilar plates</i>	55-56
Clavos cerrojados. <i>Interlocking nails</i>	57-58
Cajas y bandejas para instrumental y tornillos. Cases and trays for implants and screws	59
Fijación externa. External fixation .	
- Rótulas, barras conectoras y elongadores. <i>Clamps connecting bars and bone lengthening device</i>	60
- Agujas rosca positiva. <i>Threaded positive profile pins</i>	61
Brocas, Agujas de Kirschner, Clavos de Steinmann, cerclajes y Kishigami <i>Drill bits, Kirschner wires, Steinmann nails, cerclages and Kishigami</i>	62
Instrumental para el atornillado. <i>Instruments for tapping and screwing</i>	63
Motores para taladros y sierra oscilante. <i>Motors for drills and oscillating saw</i>	64-66
Prótesis de cadera no cementada. <i>Cementless hip prosthesis</i>	67
Instrumental <i>Instruments</i>	68-79

PLACAS PARA TORNILLOS DE 1,5 MM DE DIAMETRO PLATES FOR 1.5 MM SCREW DIAMETER

1515-020



Mini-placa recta de 20 orificios

Longitud 100 mm Ancho 4.0 mm Grosor 1.5 mm

Straight mini-plate 20 holes Length 100 mm Width 5.0 mm Thickness 1.5 mm

Placas tornillos Ø1.5 mm Ancho 4.0 mm Grosor 1.5 mm

Plates for 1.5mm screws diameter Width 5.0mm Thickness 1.5mm

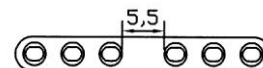

Referencia	Longitud	Orificios	Referencia	Longitud	Orificios
<i>Reference</i>	<i>Length</i>	<i>Holes</i>	<i>Reference</i>	<i>Length</i>	<i>Holes</i>
1515-004	23,5mm	4	1515-009	48,5mm	9
1515-005	28,5mm	5	1515-010	53,5mm	10
1515-006	33,5mm	6	1515-011	58,5mm	11
1515-007	38,5mm	7	1515-012	63,5mm	12
1515-008	43,5mm	8			

15RC-020



Placa reconstrucción tornillos Ø1.5 mm

Longitud 100 mm Ancho 5.0 mm Grosor 1.2 mm

Reconstruction plate 1.5 mm screws

Length 100 mm Width 5.0 mm Thickness 1.2 mm

T-15



Placa en T para tornillos Ø 1.5 mm

Longitud 27mm Ancho cabeza 7.0 Ancho cola 4.0 Grosor 1.5mm

T-plate Length 27mm Thickness 1.5mm Width of T head 7.0mm Width plate shaft 4.0mm

GD-1115

Guía de broca dentada doble de 1.1-1.5 mm

Indented drill guide 1.1-1.5 mm

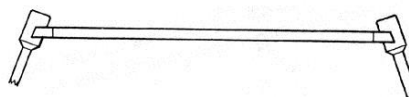

Tornillos Ø 1,5 mm cabeza hexagonal *Ø 1.5 mm cortical screws / hexagonal head*

Referencia	Longitud	Referencia	Longitud
<i>Reference</i>	<i>Length</i>	<i>Reference</i>	<i>Length</i>



0015-006	6 mm	0015-014	14 mm
0015-007	7 mm	0015-016	16 mm
0015-008	8 mm	0015-018	18 mm
0015-009	9 mm	0015-020	20 mm
0015-010	10 mm	0015-022	22 mm
0015-011	11 mm	0015-024	24 mm
0015-012	12 mm		

PM-15 Pasamachos tornillos 1,5 mm anclaje rápido
Tap 1.5 mm screws with quick fit

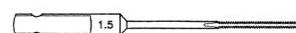

B-15

Broca Ø 1.1 mm para tornillos de 1,5mm. Longitud 60 mm
Drill Ø1,1 mm for 1.5 screws. Length 60 mm

**MAR-R**

Mango de anclaje rápido recto

Handle with quick fit

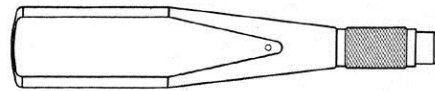
**MAR-T**

Mango en T anclaje rápido

T handel with quick fi

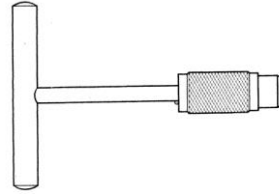
**AV-11**

Avellanador punta 1.1 mm tornillos 1,5

Countersink point 1,1 mm with quick fit (not dental fit)

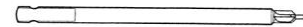
**AV-11T**

Avellanador punta 1.1 mango en T

Countersink point 1,1 mm T handle

**AT-15**

Miniatornillador tornillos de 1,5-2.0 (sin pinza)

Miniscrew driver for 1.5-2.0 screws without forceps

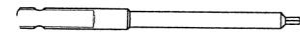
**AT-15P**

Miniatornillador con pinza tornillos de 1,5-2.0

Miniscrew driver with forceps for screws 1.5-2.0 with quick fit (not dental fit)

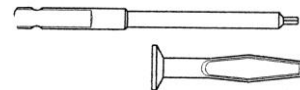
**AT-15M**

Miniatornillador tornillos de 1,5-2.0 con mango y sin pinza

Miniscrew driver without forceps and handle for 1.5-2.0 mm screws

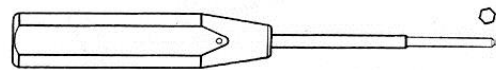
**AT-15MP**

Miniatornillador tornillos de 1,5-2.0 con mango y pinza

Miniscrew driver for 1.5-2.0 mm screws with forceps and handle

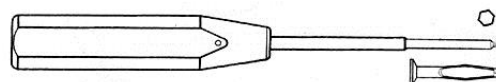

PLACAS BLOQUEADAS TORNILLOS Ø 1.5 mm LOCKING PLATES 1.5 Ø SCREWS

PB1515-020

Mini-placa bloqueada recta de 20 orificios

Straight mini-locking plate 20 holes

Longitud/ *Lenght* 100 mm

Ancho/ *Width* 4.0 mm

Grosor *Thickness* 2.0/1.5 mm



PB15RC-020

Mini-placa bloqueada recta de reconstrucción de 20 orificios

Straight mini-locking reconstruction plate 20 holes

Longitud/ *Lenght* 100 mm Ancho/ *Width* 4.0 mm

Grosor *Thickness* 2.0/1.5 mm



PBT-15

Placa bloqueada en T para tornillos Ø 1.5 mm

T-locking plate

Longitud/ *length* 26,5mm

Ancho cabeza/ *Width of T head* 7.0mm

Ancho cola/ *Width plate shaft* 4.0mm

Grosor *Thickness* 2.0/1.5mm

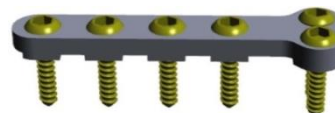

GBPB-011

Guía broca placa bloqueada broca 1.1 mm

Drill guide for drill 1.1mm

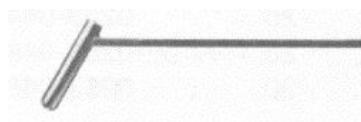

PB15-004

Placa bloqueada *locking plate*

Longitud/ *Lenght* 24mm

Ancho/ *Width* 4.0mm

Grosor/ *Thickness* 2.0/1.5mm

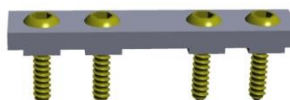

PB15-006

Placa bloqueada *locking plate*

Longitud/ *Lenght* 34 mm

Ancho/ *Width* 4.0 mm

Grosor/ *Thickness* 2.0/1.5mm



PB15-008

Placa bloqueada *locking plate*

Longitud/ *Lenght* 44 mm

Ancho/ *Width* 4.0 mm

Grosor/ *Thickness* 2.0/1.5m



PB15-010

Placa bloqueada *locking plate*

Longitud/ *Lenght* 54 mm

Ancho/ *Width* 4.0 mm

Grosor/ *Thickness* 2.0/1.5mm



PLACAS PARA TORNILLOS DE 2.0 MM DE DIAMETRO

PLATES FOR 2.0 MM SCREW DIAMETER

2020-020

Placa cortable 20 orificios ovalados



Longitud 100 mm Ancho 5.0 mm Grosor 1.5

Cut-to-length plate 20 round orifices Length 100 mm Width 5.0 mm Thickness 1.5 mm

2020-025



Placa cortable 25 orificios redondos

Longitud 150 mm Ancho 7.0 mm Grosor 2.0 mm

Cut-to-length plate 25 orifice Length 150 mm Width 7.0 mm Thickness 2.0 mm

20RC-021



Placa reconstrucción cortable 30 orificios Longitud 150 mm Ancho 5.0 mm Grosor 1.5 mm

Cut-to-length reconstruction plate 30 orifice Length 150 mm Width 5.0 mm Thickness 1.5 mm

Placas DCP tornillos Ø2.0 mm Ancho/ *Width* 5.0 mm

Grosor/*Thickness* 1.5 mm



Plates for 2.0mm screws diameter

Referencia <i>Reference</i>	Longitud <i>Length</i>	Orificios <i>Holes</i>	Referencia <i>Reference</i>	Longitud <i>Length</i>	Orificios <i>Holes</i>
2020-004	22mm	4	2020-009	48 mm	9
2020-005	27mm	5	2020-010	53 mm	10
2020-006	32mm	6	2020-011	58mm	11
2020-007	37mm	7	2020-012	63mm	12
2020-008	42mm	8			

Placas en L 2.0mm

Grosor 0.9mm

L-Plate 2.0mm

Thickness 0.9mm



2020-031 Izquierda/Left

2020-032 Derecha/Right

Placas oblicuas 2.0mm

Grosor 0.9mm

Oblique Plate 2.0mm

Thickness 0.9mm



2020-033 Izquierda/Left

2020-034 Derecha/Right

Placa en T 2.0mm

Grosor 0.9mm

T-Plate 2.0mm

Thickness 0.9mm



2020-041

T-20C

Placa en T Corta Longitud total 28mm

Ancho cabeza 9.0mm Ancho cola 5.0mm

Grosor 1.5mm

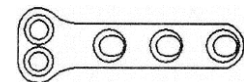

T-Short plate

Total length 28mm

Width of T head 9mm

Width plate shaft 5mm

Thickness 1.5mm

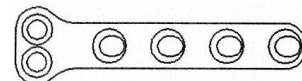

T-20L

Placa en T Larga *T-Long plate* Longitud total 35mm *Total length 35mm*

Ancho cabeza/*Width of T head* 9.0mm Ancho cola/*Width plate shaft* 5.0mm

Grosor/*Thickness* 1.5mm

Placas orificios redondos para tornillos de 2.0/2.4/2.7 mm.

Ancho 7.0mm / Grosor 2.0 mm (animales hasta 4-5 kg).

Round holes plates for 2.0/2.4/2.7 mm screws diameter.

Width 7.0mm / Thickness 2.0mm (use in animals until 4-5 kg).



Referencia <i>Reference</i>	Longitud <i>Length</i>	Orificios <i>Holes</i>	Referencia <i>Reference</i>	Longitud <i>Length</i>	Orificios <i>Holes</i>	
2027-004	34mm	4	2027-009	64mm	9	
2027-005		40mm	5	2027-010	70mm	10
2027-006		46mm	6	2027-011	73mm	11
2027-007		52mm	7	2027-012	78mm	12
2027-008		58mm	8			

Placas sostén para tornillos 2.0/2.7mm. Ancho 7.0mm Grosor 2.0mm (perros y gatos hasta 4-5 kg)

Butress plates 2.0/2.7mm screws. Width 7.0mm Thickness 2.0mm (dogs and cats until 4-5 kg)

2020-070 Longitud 70mm / **Length 70mm**

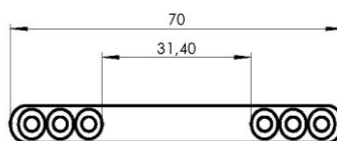

2020-080 Longitud 70mm / **Length 70mm**

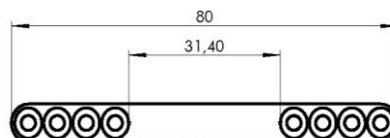

2020-090 Longitud 70mm / **Length 70mm**

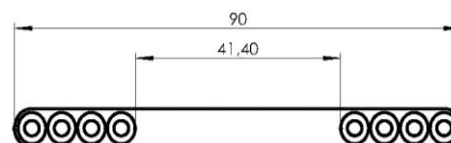

2020-100 Longitud 70mm / **Length 70mm**

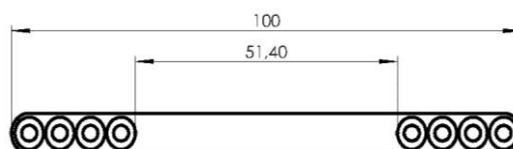

Tornillos de cortical Ø 2.0 mm autoroscantes

Cortical self-taping screws Ø 2.0 mm

Referencia <i>Reference</i>	Longitud <i>Length</i>	Referencia <i>Reference</i>	Longitud <i>Length</i>	Referencia <i>Reference</i>	Longitud <i>Length</i>
0020-006	6 mm	0020-018	18 mm	0020-030	30 mm
0020-008	8 mm	0020-020	20 mm	0020-032	32 mm
0020-010	10 mm	0020-022	22 mm	0020-034	34 mm
0020-012	12 mm	0020-024	24 mm	0020-036	36 mm
0020-014	14 mm	0020-026	26 mm	0020-038	38 mm
0020-016	16 mm	0020-028	28 mm	0020-040	40 mm

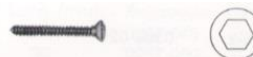

GDCP-15

Guía de broca placas DCP broca Ø 1.5 mm

Ø 1.5mm DCP drill guide for 2.0mm screws



GD-1520

Guía de broca dentada doble 1.5/2.0mm
Indented 1.5mm/2.0mm double drill sleeve

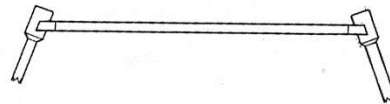
**PM-20**

Pasamachos anclaje rápido tornillos 2.0 mm
Tap for 2.0 mm screws with quick fit

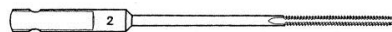
**PM-20T**

Pasamachos mango T tornillos 2.0
Tap for 2.0 mm screws with handle

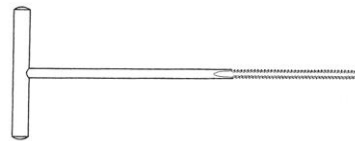
**AV-15**

Avellanador anclaje rápido punta 1.5 mm
Countersink for 2.0 mm cortex screws

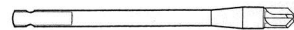
**AV-15T**

Avellanador mango T punta 1.5
Countersink for 2.0 mm cortex screws with handle

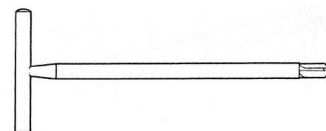
**AT-15**

Atornillador punta hexagonal tornillos Ø 1.5/2.0mm (sin pinza)
Screw driver hexagonal point without forceps for screws 1.5-2.0 with quick fit (not dental fit)

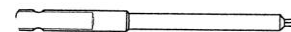
**AT-15P**

Atornillador punta hexagonal con pinza tornillos Ø 1.5-2.0mm
Screw driver hexagonal point with forceps for 1.5-2.0 screws with quick fit

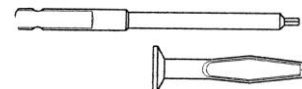
**AT-15M**

Atornillador punta hexagonal tornillos Ø 1.5/2.0mm con mango y sin pinza
Screw driver hexagonal point without forceps and handle for 1.5/2.0 mm screws

AT-15MP

Atornillador punta hexagonal tornillos Ø 1.5-2.0 con mango y pinza
Screw driver hexagonal point with forceps and handle for 1.5-2.0 mm screws

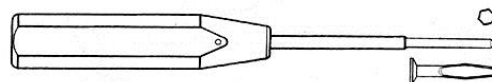
**MT-20**

Medidor de longitud tornillos 2.0 mm
Depth gauge for 2.0 mm screws

**A-45**

Arandela inox diámetro 4.5 mm tornillos 2.0 mm
Washer for 2.0 mm screws



PLACAS BLOQUEADAS TORNILLOS Ø 2.0 mm LOCKING PLATES 2.0 Ø SCREWS

PB20RC-021 Placa bloqueada reconstrucción cortable 30 orificios

Cut-to-length reconstruction locking plate 30 orifices

Longitud/ *Length* 150 mm Ancho/ *Width* 5.0 mm Grosor

/ *Thickness* 2.5 mm



PB2020-025 Placa bloqueada de bajo contacto cortable 25 orificios redondos

Cut-to-length low contact locking plate 25 orifice

Longitud/ *length* 150 mm Ancho/ *Width* 7.0 mm Grosor

Thickness 2.5/2.0mm



Placas bloqueadas de bajo contacto sostén para tornillos 2.0mm.

Ancho/ *Width* 7.0mm Grosor/ *Thickness* 2.5/2.0mm

Butress low contact locking plates 2.0mm screws.

PB2020-070

Longitud/ *Length* 70mm

PB2020-080

Longitud/ *Length* 80mm



PB2020-090

Longitud/ *Length* 90mm

PB2020-100

Longitud/ *Length* 100mm

Placas bloqueadas de fémur *Femoral locking plates*

PBFD-20

Placa fémur derecho/ **Right femoral plate**

Longitud/ *length* 6.0 cm Grosor/ *Thickness* 2.5mm



PBFI-20

Placa fémur izquierdo **Left femoral plate**



PBFED-20

Placa fémur derecho/ **Right femoral plate**

Long/ *Length*: 51mm Grosor/ *Thickness*: 2.5mm Ancho/ *Width*: 6.0mm

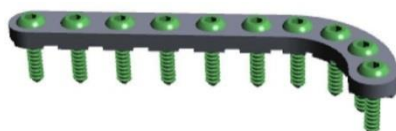

PBFEI-20

Placa fémur izquierdo **Left femoral plate**

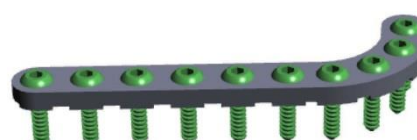

PBT20-015D Grosor/*Thickness* 2.5/2.0mm
Placa bloqueada panartrodesis tarso derecho por cara lateral
Right lateral tarsal panarthrodesis locking plate



PBT20-015I
Placa bloqueada panartrodesis tarso izquierdo por cara lateral
Left lateral tarsal panarthrodesis locking plate



PBTPL0-020
Placa cobra bloqueada *Cobra locking plate*
Longitud / *Length* 39.0mm
Cabeza / *width of T head* 10mm
Cola / *width plate shaft* 6.0mm
Grosor / *thickness* 2.5mm

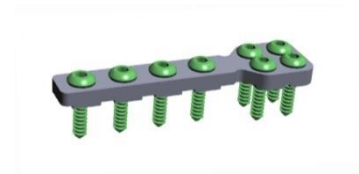

PBT-20C Placa en T bloqueada corta
T-Short low contact locking plate
Total length 28 mm
Width of T head 9.0mm
Width plate shaft 5.0mm
Thickness 2.5/2.0mm



PBT-20L Placa en T bloqueada larga
T-Long low contact locking plate
Total length 35mm
Width of T head 9.0mm
Width plate shaft 5.0mm
Thickness 2.5/2.0mm

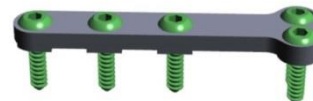

PBACET-020 Placa bloqueada acetabular
Acetabular locking plate



GBPB-1520
Guía broca placa bloqueada broca 1.5-2.0 mm
Drill guide for 1.5-2.0 mm drill

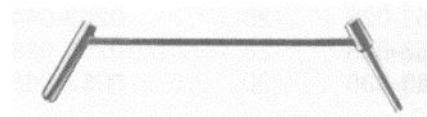

PLACAS PARA TORNILLOS DE 2.4 MM DE DIAMETRO PLATES FOR 2.4 MM SCREW DIAMETER

Placas DCP para tornillos Ø 2.0/2.4/2.7 mm

Ancho 6.7 mm Grosor 2.5 mm

Plates for 2.4 mm screw diameter. Also can be used

with 2.0 and 2.7mm screws. Width 7.0mm Thickness 2.0mm



Referencia <i>Reference</i>	Longitud <i>Length</i>	Orificios <i>Holes</i>	Referencia <i>Reference</i>	Longitud <i>Length</i>	Orificios <i>Holes</i>
2424-004	31.15mm	4	2424-009	66.15mm	9
2424-005	38.15mm	5	2424-010	73.15mm	10
2424-006	45.15mm	6	2424-011	80.15mm	11
2424-007	52.15mm	7	2424-012	87.15mm	12
2424-008	59.15mm	8			

Tornillos de acero Ø 2.4 mm autoroscantes

Cortical self-taping screws Ø 2.4 mm

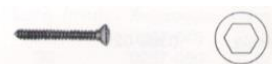

Referencia <i>Reference</i>	Longitud <i>Length</i>	Referencia <i>Reference</i>	Longitud <i>Length</i>	Referencia <i>Reference</i>	Longitud <i>Length</i>
0024-006	6 mm	0024-018	18 mm	0024-030	30 mm
0024-008	8 mm	0024-020	20 mm	0024-032	32 mm
0024-010	10 mm	0024-022	22 mm	0024-034	34 mm
0024-012	12 mm	0024-024	24 mm	0024-036	36 mm
0024-014	14 mm	0024-026	26 mm	0024-038	38 mm
0024-016	16 mm	0024-028	28 mm	0024-040	40 mm

2424-070

Placa sostén 2.4 70 mm longitud

Butress plate 2.4, 70mm length

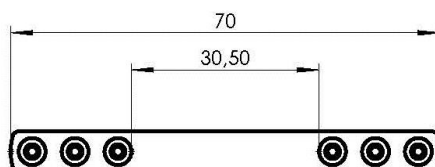

2424-080

Placa sostén 2.4 80 mm longitud

Butress plate 2.4, 80mm length

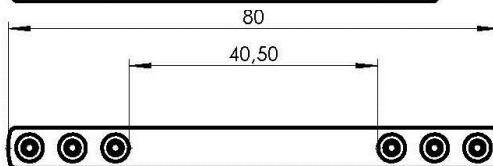

2424-090

Placa sostén 2.4 90 mm longitud

Butress plate 2.4, 90mm length

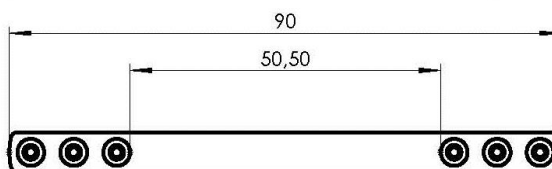

2424-100

Placa sostén 2.4 100 mm longitud

Butress plate 2.4, 100mm length

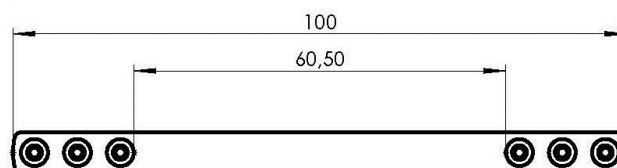

PLACAS BLOQUEO PARA TORNILLOS DE 2.4 MM DE DIAMETRO *LOCKING PLATES FOR 2.4 MM SCREW DIAMETER*

PB2424-070

Placa bloqueo 2.4 70 mm longitud
Locking plate 2.4 70mm length



PB 2424-080

Placa bloqueo 2.4 80 mm longitud
Locking plate 2.4 80mm length



PB 2424-090

Placa bloqueo 2.4 90 mm longitud
Locking plate 2.4 90mm length



PB 2424-100

Placa bloqueo 2.4 100 mm longitud
Locking plate 2.4 100mm length



PB2424-020

Placa bloqueo 2.4 20 orificios
Locking plate 2.4 20 holes



TPLO-24

Placa TPLO cobra 2.4
TPLO plate 2.4



PBTPLO-24

Placa bloqueo TPLO tornillo 2.4
Locking TPLO plate 2.4

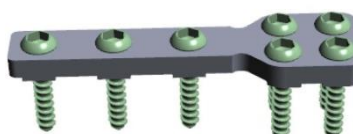

PLACAS PARA TORNILLOS DE 2.7 MM DE DIAMETRO PLATES FOR 2.7 MM SCREW DIAMETER

Placas DCP tornillos Ø2.7 mm *Plates for 2.7mm screws diameter*

Ancho 8.0 mm Grosor 2.5 mm

Width 8.0mm Thickness 2.5mm



Referencia <i>Reference</i>	Longitud <i>Length</i>	Orificios <i>Holes</i>	Referencia <i>Reference</i>	Longitud <i>Length</i>	Orificios <i>Holes</i>
2727-004	36mm	4	2727-009	76mm	9
2727-005	44mm	5	2727-010	84mm	10
2727-006	52mm	6	2727-011	92mm	11
2727-007	60mm	7	2727-012	100mm	12
2727-008	68mm	8			

2727-020



Placa cortable 20 orificios ovalados *2.7 mm cut to length plate oval holes*

Longitud 140 mm

Ancho 8.0 mm

Grosor 2.5 mm

Length 140 mm

Width 8.0 mm

Thickness 2.5 mm

27RC-022



Placa reconstrucción 25 orificios REDONDOS

Longitud 150 mm

Ancho 7.0 mm

Grosor 2.0 mm

2.7mm cut to length reconstruction plate 25 ROUND holes

Length 150 mm

Width 7.0 mm

Thickness 2.0mm

27RC-023



Placa cortable de reconstrucción 2.7mm. 24 orificios ovalados.

2.7 mm cut to length reconstruction plate 24 oval holes

Longitud 190 mm

Ancho 8.0 mm

Grosor 2.8 mm

Length 190 mm

Width 8.0mm

Thickness 2.8mm

GDCP-27

Guía broca DCP para tornillos de 2.7 mm

2.7 mm screws DCP drill guide



T-27

Placa en T 2.7mm. Longitud total 55mm *2.7mm T-Plate. Total length 55mm*

Ancho cabeza 12.5 mm Grosor 2.5mm *Thickness 2.5mm*

Width of T head 12.5 mm

Ancho cola 7.0 mm *Width plate shaft 7.0mm*

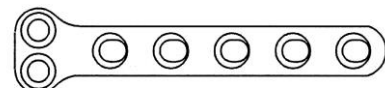

T-27C

Tornillo 2.7 mm / *Screw 2.7mm* Longitud / *length 40mm*

Ancho cabeza / *Width of T head 16mm*

Ancho cola / *Width plate shaft 8.0mm*

Grosor / *Thickness 2.5mm*

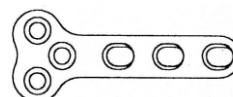

*Placas de sostén 2.7mm orificios redondos. Butress plate 2.7mm round holes.
Ancho 8mm. Grosor 2.5mm Width 8.0mm Thickness 2.5 mm*

2727-070
Longitud 70mm/*Length 70*

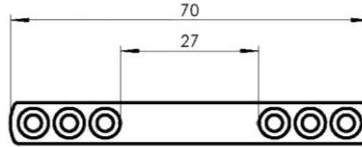

2727-080
Longitud 80mm/*Length 80*

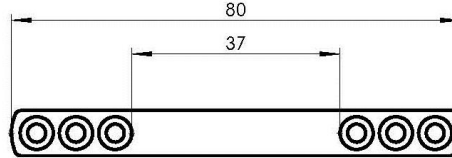

2727-090
Longitud 90mm/*Length 90*

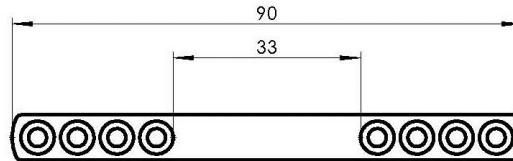

2727-100
Longitud 100mm/*Length 100*

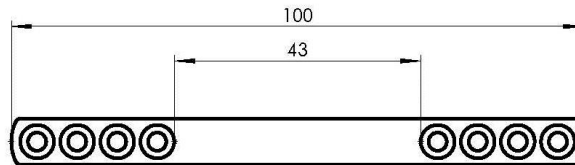

2727-110
Longitud 110mm/*Length 110*

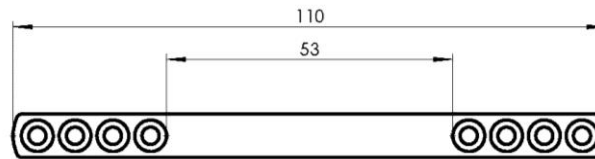

2727-120
Longitud 120mm/*Length 120*

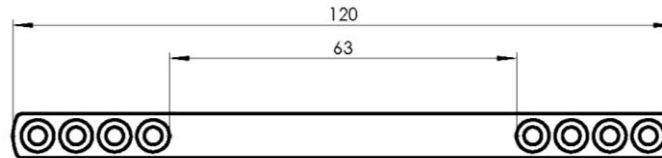

2727-130 Longitud
130mm/*Length 130mm*

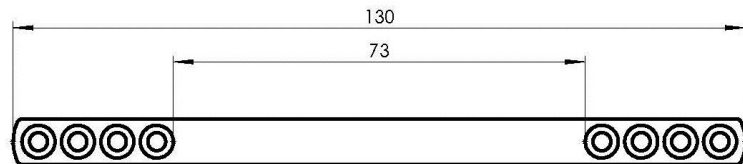

Placas en L 2.7mm
Grosor 0.9mm
*L-Plate 2.7mm
Thickness 0.9mm*



2727-032 Derecha/*Right*
2727-031 Izquierda/*Left*

Placas oblicuas 2.7mm
Grosor 0.9mm
*Oblique Plate 2.7mm
Thickness 0.9mm*

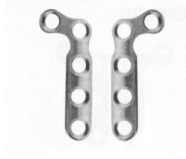

2727-034 Derecha/*Right*
2727-033 Izquierda/*Left*

Placa en T 2.7mm
Grosor 0.9mm
*T-Plate 2.7mm
Thickness 0.9mm*



2727-041

Tornillos de cortical Ø 2.7 mm autoroscantes
Cortical self-taping screws Ø 2.7 mm

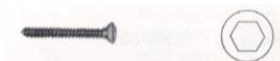

Referencia	Longitud	Referencia	Longitud	Referencia	Longitud
<i>Reference</i>	<i>Length</i>	<i>Reference</i>	<i>Length</i>	<i>Reference</i>	<i>Length</i>
0027-006	6 mm	0027-018	18 mm	0027-030	30 mm
0027-008	8 mm	0027-020	20 mm	0027-032	32 mm
0027-010	10 mm	0027-022	22 mm	0027-034	34 mm
0027-012	12 mm	0027-024	24 mm	0027-036	36 mm
0027-014	14 mm	0027-026	26 mm	0027-038	38 mm
0027-016	16 mm	0027-028	28 mm	0027-040	40 mm

GBD-2027

Guía de broca dentada doble 2.0-2.7 mm

Indented drill guide 2.0-2.7mm

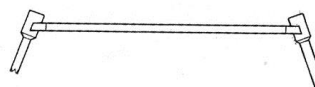

B-20

Broca Ø 2.0mm longitud 100 mm

Bit drill Ø 2.0mm. Length 100mm

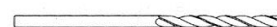

B-27

Broca Ø 2.7mm longitud 130 mm

Bit drill Ø 2.7mm. Length 130mm



AV-20

Avellanador cierre rápido punta 2.0mm

Countersink with quick fit 2.0 mm



AV-20T

Avellanador en T punta 2.0 mm

Countersink with handle 2.0 mm

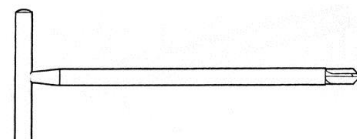

PM-27

Pasamachos 2.7mm cierre rápido

Tap 2.7mm with quick fit

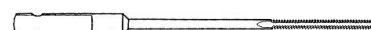

PM-27T

Pasamachos 2.7mm mango en T

Tap 2.7 with handle

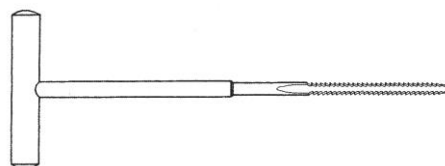

AT-27

Atornillador cierre rápido sin pinza para tornillos 2.7/3.5/4.0 mm

Screw driver without forceps for 2.7-3.5 and 4.0 with quick fit

Screw driver with forceps for 2.7-3.5 and 4.0 with quick fit



AT-27P

Atornillador cierre rápido con pinza para tornillos 2.7/3.5/4.0

Screw driver with forceps for 2.7-3.5 and 4.0 with quick fit

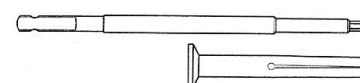

AT-27M

Atornillador con mango sin pinza tornillos 2.7-3.5-4.0mm

Screw driver with handle without forceps for 2.7-3.5 and 4.0 mm screws

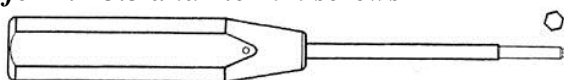

AT-27MP

Atornillador con mango y pinza para tornillos 2.7-3.5-4.0mm

Screw driver with handle and forceps for 2.7-3.5 and 4.0 mm screws

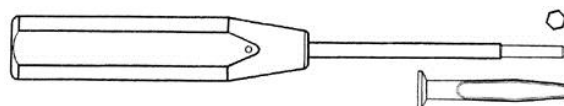

MT-27

Medidor de longitud tornillos 2.7 mm

Depth gauge for 2.7mm screws

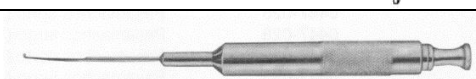

A-070

Arandela diámetro 7.0 mm tornillos 2.7-3.5-4.0mm

Washer 7.0 mm for 2.7-3.5 and 4.0mm screws



CP-35

Centrador perforación broca 3.5mm

3.5 mm pointed drill guide

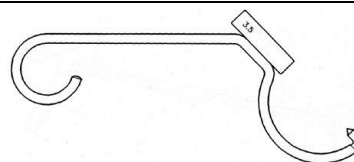

C27-20

Casquillo diámetro exterior 2.7mm broca 2.0mm

Drill guide external diameter 2.7mm drill 2.0mm

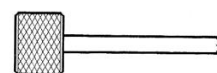

C35-27

Casquillo diámetro exterior 3.5mm broca 2.7mm

Drill guide external diameter 3.5mm drill 2.7mm

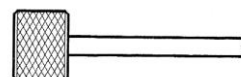

C35-25

Casquillo diámetro exterior 3.5mm broca 2.5mm

Drill guide external diameter 3.5mm drill 2.5mm

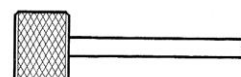

C35-20

Casquillo diámetro exterior 3.5mm broca 2.0mm

Drill guide external diameter 3.5mm drill 2.0mm

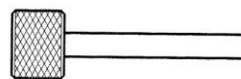

Los casquillos C35-27, C35-20, C35-025 puede utilizarse con el centrador de perforación CP-35

The drill guide C35-27, C35-20, C35-025 can be used with the pointed drill guide CP-35

Util para la inserción de tornillos a tracción en fracturas intercondilares del húmero

Useful for lag screws insertion in humeral intercondilar fractures

PLACAS BLOQUEADAS TORNILLOS Ø 2.7 mm **LOCKING PLATES 2.7 Ø SCREWS**

PB27RC-022

Placa bloqueada de reconstrucción 25 orificios *2.7mm cut to length reconstruction locking plate 25 holes* Longitud/ *Length 150 mm*

Ancho/*Width 7.0mm* Grosor/*Thickness 3.0/2.5mm*



PB27RC-023

Placa cortable reconstrucción 24 orificios *2.7 mm cut to length reconstruction plate 24holes* Longitud /*Length 192 mm* Ancho/*Width 8.0mm*

Grosor/*Thickness 3.0/2.5mm mm*



PB2727-020

Placa bloqueada cortable 20 orificios *2.7 mm cut to length locking plate 20 holes*

Longitud *Length 140 mm* Ancho/ *Width 8.0 mm*

Grosor/*Thickness 3.0 mm*



PB2727-025

Placa bloqueada cortable 25 orificios *Cut-to-lenght locking plate 25 orifices*

Longitud/ *length 150 mm* Ancho/ *Withd 7.0 mm*

Grosor/*Thickness 3.0/2.5 mm*



Placas bloqueadas sostén/ *Butress locking-plate* Ancho/*Width 8.0mm* *Thickness 3.0 mm*

PB2727-070

Longitud/*Length 70mm*

PB2727-080

Longitud *Length 80mm*



PB2727-090

Longitud 90mm/*Length 90mm*

PB2727-100

Longitud/*Length 100mm*

PB2727-110

Longitud 110mm/*Length 110mm*



PB2727-120

Longitud 120mm/*Length 130mm*

PB2727-130

Longitud 130mm/*Length 130mm*

Placas bloqueadas para fracturas distales de fémur

Locking -plates for distal femoral fractures Grosor/Thickness 3.0/2.5mm

PBFD-27L

Placa para fémur derecho larga 80 mm
Long locking plate right femur 80 mm length



PBFI-27L

Placa para fémur izdo larga
Long locking plate left femur



PBFD-27C

Placa para fémur derecho corta 60 mm
Short locking plate right femur length 60 mm



PBFI-27C

Placa para fémur izdo corta
Short locking plate left femur

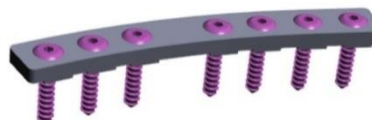

PBFED-27

Placa bloqueo supracondilar femur derecho
Right supracondilar femoral locking plate



PBFEI-27

Placa bloqueo fémur izquierdo
Locking plate left femur



PBT27-020D

Placa bloqueada panartrodesis tarso lateral derecho.
Parte proximal: tornillo 2.7mm/Grosor 3.0/2.5mm
Parte distal: Tornillo 2.0mm/Grosor 2.5mm
Right lateral tarsal panarthrodesis locking plate
Proximal thickness low contact 3.0/2.5mm. screw 2.7mm
Distal thickness 2.5mm. Screw 2.0mm



PBT27-020I

Tarso lateral izquierdo
Left lateral tarsal



PBT-27

Placa bloqueada en T 2.7mm. Longitud total 55mm
2.7mm T- Locking Plate. Total length 55mm

Ancho cabeza/*Width of T head 13mm*
Ancho cola/*Width plate shaft 7.0mm*
Grosor/*Thickness 3.0/2.5mm*

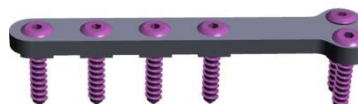

PBT-27C Placa bloqueada en T corta
2.7mm low contact T- Locking plate

Longitud / *length 40mm*
Ancho cabeza / *Width of T head 16mm*
Ancho cola / *Width plate shaft 8.0mm*
Grosor / *Thickness 3.0/2.5mm*



Placas bloqueadas cobra de bajo contacto
Low contact cobra tibial locking plate for CTWO

PBTPLO-27C

Longitud / *Length 48.0mm*
Cabeza / *width of T head 14mm*
Cola / *width plate shaft 8.0mm*
Grosor / *thickness 3.0/2.5mm*



PBTPLO-27L

Longitud / *Length 59.0mm*
Cabeza / *width of T head 16mm*
Cola / *width plate shaft 10.0mm*
Grosor / *thickness 3.0/2.5mm*

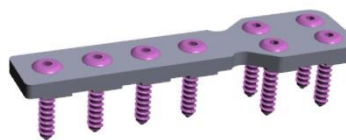

PBTPLO-27G

Longitud / *Length 66mm*
Cabeza / *width of T head 17mm*
Cola / *width plate shaft 11.0mm*
Grosor / *thickness 3.0/2.5mm*

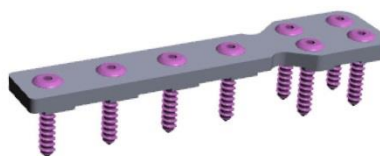

PBACET-027

Placa acetabular bloqueada bajo
contacto
Acetabular locking plate 2.7mm screws



GBPB-1520

Guía broca placas bloqueadas broca 1.5-2.0mm
Drill guide locking plate drill 1.5-2.0mm

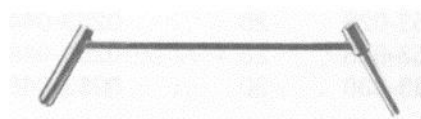

PLACAS PARA TORNILLOS DE 3.5 MM DE DIAMETRO
PLATES FOR 3.5 MM SCREWS DIAMETER

Placas DCP 3.5mm 3.5mm DCP plates
Ancho 10.2mm Grosor 3.2mm
Width 10.2mm Thickness 3.0mm



Referencia <i>Reference</i>	Longitud <i>Length</i>	Orificios <i>Holes</i>	Referencia <i>Reference</i>	Longitud <i>Length</i>	Orificios <i>Holes</i>
3535-E04	49mm	4	3535-E09	109mm	9
3535-E05	61mm	5	3535-E10	121mm	10
3535-E06	73mm	6	3535-E11	133mm	11
3535-E07	85mm	7	3535-E12	145mm	12
3535-E08	97mm	8			

Placas DCP reforzadas 3.5mm 3.5mm broad DCP plate
Ancho 12mm Grosor 4.0mm
Width 12mm Thickness 4.0mm



Referencia <i>Reference</i>	Longitud <i>Length</i>	Orificios <i>Holes</i>	Referencia <i>Reference</i>	Longitud <i>Length</i>	Orificios <i>Holes</i>
3535-A04	50mm	4	3535-A09	111mm	9
3535-A05	63mm	5	3535-A10	120mm	10
3535-A06	73mm	6	3535-A11	132mm	11
3535-A07	86mm	7	3535-A12	144mm	12
3535-A08	97mm	8			

35RC-024



Placa de reconstrucción 3.5mm 22 orificios 3.5mm cut-to-length reconstruction plate 22 holes

Longitud 260mm Ancho 10.0mm Grosor 2.8mm
Length 260mm Width 10 mm Thickness 2.8mm

T-35 Placa en T 3.5mm. Longitud total 80mm 3.5mm T-Plate. Total length 80mm
Ancho cabeza 18mm Ancho cola 11mm Grosor 3.0mm
Width of T head 18mm Width plate shaft 11mm Thickness 3.0mm

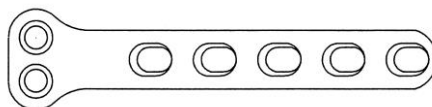

Placas en T 3 orificios en cabeza T plates with three head holes
T-35C

Longitud/Length: 55.0mm
Cabeza/width of T head: 22.0mm
Cola/width plate shaft: 10.0mm
Grosor cabeza /Head thickness: 3.0mm

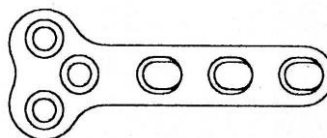

T-35L
Longitud/Length: 78.0mm
Cabeza/width of T head: 24.0mm
Cola/width plate shaft: 12.0mm
Grosor cabeza/Head thickness: 3.0mm

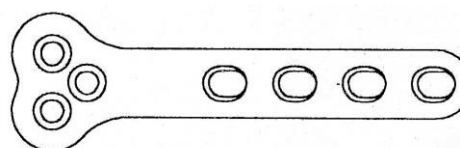

Placas de sostén 3.5mm orificios redondos (utilizar guía de broca 449-2532).

Ancho 10.2mm Grosor 3.2 mm

Butress plate 3.5mm round holes (use drill guide 449-2532).

Width 10.2mm Thickness 3.2mm

3535-E100

Longitud 100mm

Length 100mm

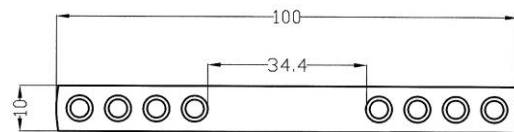

3535-E120

Longitud 120mm

Length 120mm

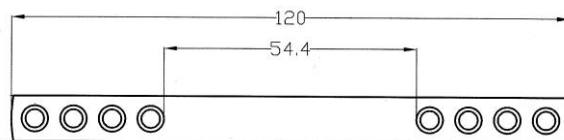

3535-E140

Longitud 140mm

Length 140mm

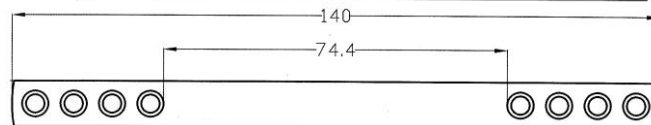

3535-E160

Longitud 160mm

Length 160mm

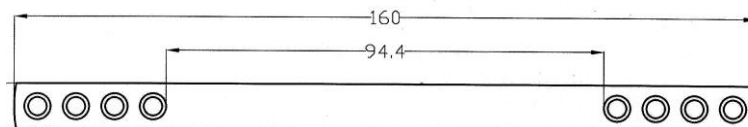

Placas de sostén reforzadas 3.5mm orificios redondos *Butress broad plate 3.5mm* round holes Ancho 12.0mm Grosor 4.0mm Width 12.0mm Thickness 4.0mm

3535-A100

Longitud 100mm

Length 100mm

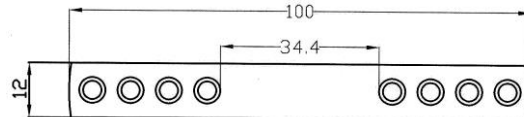

3535-A120

Longitud 120mm

Length 120mm

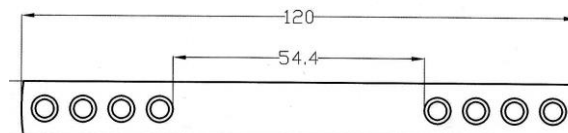

3535-A140

Longitud 140mm

Length 140mm

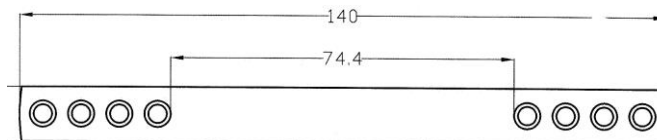

3535-A160

Longitud 160mm

Length 160mm

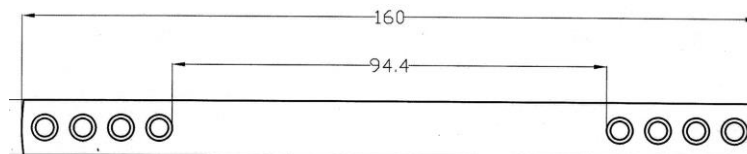

3535-A180

Longitud 180mm

Length 180mm

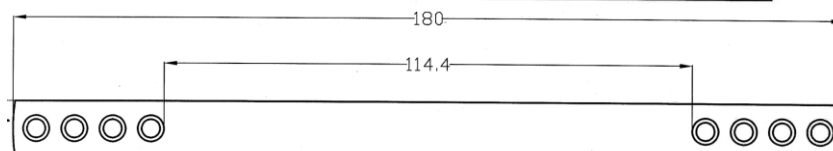

CP-35
Centrador perforación broca 3.5mm
3.5 mm pointed drill guide

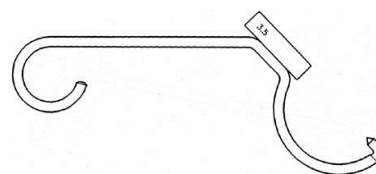

C-3525
Casquillo diámetro externo 3.5 broca 2.5mm
Drill guide external diameter 3.5 drill 2.5mm

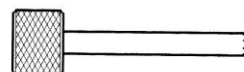

GDCP-35
Guía broca DCP tornillo 3.5mm
3.5 mm screws DCP drill guide



B-25
Broca Ø 2.5mm. Longitud 130 mm
Drill Bit Ø 2.5mm. Length 130mm

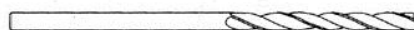

B-35
Broca Ø 3.5mm. Longitud 130 mm
Drill Bit Ø 3.5mm. Length 130mm



Tornillos de cortical Ø 3.5 mm autoroscantes *Cortical self-taping screws Ø 3.5 mm*
Paso de rosca 1.25mm *Pitch of thread 1.25mm*

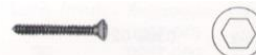

Referencia	Longitud	Referencia	Longitud	Referencia	Longitud
<i>Reference</i>	<i>Length</i>	<i>Reference</i>	<i>Length</i>	<i>Reference</i>	<i>Length</i>
0035-010	10 mm	0035-022	22 mm	0035-034	34 mm
0035-012	12 mm	0035-024	24 mm	0035-036	36 mm
0035-014	14 mm	0035-026	26 mm	0035-038	38 mm
0035-016	16 mm	0035-028	28 mm	0035-040	40 mm
0035-018	18 mm	0035-030	30 mm	0035-045	45 mm
0035-020	20 mm	0035-032	32 mm	0035-050	50 mm

Tornillos de cortical Ø 3.5 mm *Cortical screws Ø 3.5 mm*
Paso de rosca 1.75mm *Pitch of thread 1.75mm*

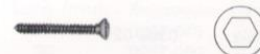

Referencia	Longitud	Referencia	Longitud	Referencia	Longitud
<i>Reference</i>	<i>Length</i>	<i>Reference</i>	<i>Length</i>	<i>Reference</i>	<i>Length</i>
0036-010	10 mm	0036-022	22 mm	0036-034	34 mm
0036-012	12 mm	0036-024	24 mm	0036-036	36 mm
0036-014	14 mm	0036-026	26 mm	0036-038	38 mm
0036-016	16 mm	0036-028	28 mm	0036-040	40 mm
0036-018	18 mm	0036-030	30 mm	0036-045	45 mm
0036-020	20 mm	0036-032	32 mm	0036-050	50 mm

Tornillos de ESPONJOSA Ø 4.0 mm ROSCA COMPLETA
Paso de rosca 1.75mm



4.0 Ø cancellous screw full threaded *Pitch of thread 1.75mm*

Referencia	Longitud	Referencia	Longitud	Referencia	Longitud
<i>Reference</i>	<i>Length</i>	<i>Reference</i>	<i>Length</i>	<i>Reference</i>	<i>Length</i>
0040-010	10 mm	0040-022	22 mm	0040-040	40 mm
0040-012	12 mm	0040-024	24 mm	0040-045	45 mm
0040-014	14 mm	0040-026	26 mm	0040-050	50 mm
0040-016	16 mm	0040-028	28 mm	0040-055	55 mm
0040-018	18 mm	0040-030	30 mm	0040-060	60 mm
0040-020	20 mm	0040-035	35 mm		

Tornillos de ESPONJOSA Ø 4.0 mm ROSCA PARCIAL

Paso de rosca 1.75mm

4.0 Ø cancellous screw partially threaded

Pitch of thread 1.75mm



Referencia	Longitud	Referencia	Longitud	Referencia	Longitud
<i>Reference</i>	<i>Length</i>	<i>Reference</i>	<i>Length</i>	<i>Reference</i>	<i>Length</i>
0041-010	10 mm	0041-022	22 mm	0041-040	40 mm
0041-012	12 mm	0041-024	24 mm	0041-045	45 mm
0041-014	14 mm	0041-026	26 mm	0041-050	50 mm
0041-016	16 mm	0041-028	28 mm	0041-055	55 mm
0041-018	18 mm	0041-030	30 mm	0041-060	60 mm
0041-020	20 mm	0041-035	35 mm		

MT-35

Medidor de longitud tornillos 3.5 mm

3.5 mm screws depth gauge

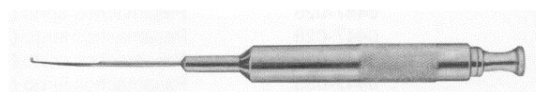

AV-25

Avellanador cierre rápido punta 2.5mm

Countersink with quick fit 2.5 mm

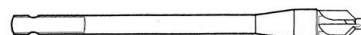

AV-25T

Avellanador en T punta 2.5 mm

Countersink with handle 2.5 mm

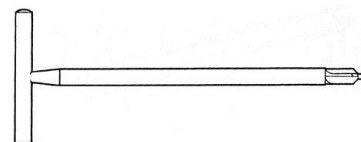

PM-34

Pasamachos Ø 3.5mm. Paso rosca 1.75mm

Tap 3.5mm with quick fit pitch of thread 1.75mm

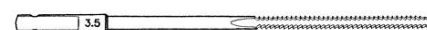

PM-35

Pasamachos Ø 3.5mm. Paso rosca 1.25mm

Tap 3.5mm with quick fit pitch of thread 1.25mm

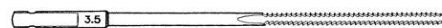

PM-34T

Pasamachos Ø 3.5mm mango en T. Paso rosca 1.75mm

Tap 3.5mm with handle of thread 1.75mm

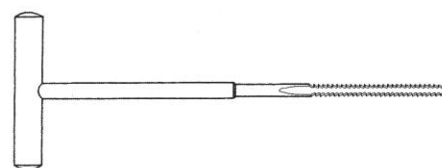

PM-35T

Pasamachos Ø 3.5mm mango en T. Paso rosca 1.25mm

Tap 3.5mm with handle of thread 1.25mm

AT-27

Atornillador cierre rápido con pinza tornillos 2.7/3.5/4.0 mm

Screw driver without forceps for 2.7/3.5/4.0 mm with quick fit

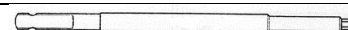

AT-27P

Atornillador cierre rápido sin pinza tornillos 2.7/3.5/4.0 mm

Screw driver with forceps for 2.7/3.5/4.0 mm with quick fit

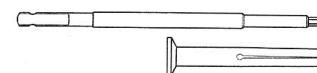

GD-2535

Guía de broca dentada doble 2.5/3.5mm

2.5/3.5 mm double drill sleeve

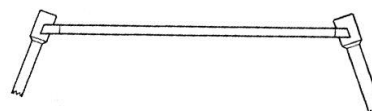

A-4.5

Arandela inoxidable diámetro 4.5 mm tornillos 2.0mm

Washer 7.0mm diameter for 2.7/3.5/4.0mm screws

A-7

Arandela inoxidable diámetro 7.0 mm tornillos 2.7/3.5/4.0mm

Washer 7.0mm diameter for 2.7/3.5/4.0mm screws

A-10

Arandela inoxidable diámetro 10 mm tornillos 2.7/3.5/4.0mm

Washer 10mm diameter for 2.7/3.5/4.0mm screws



A-13

Arandela inoxidable diámetro 13 mm tornillos 4.5mm

Washer 13mm diameter for 4.5mm screws

A-19

Arandela inoxidable diámetro 19 mm tornillos 4.5mm

Washer 19mm diameter for 4.5mm screws



PLACAS BLOQUEADAS Ø 3.5 mm LOCKING PLATES 3.5 Ø SCREWS

PB35RC-024

85€

Placa bloqueo cortable 22 orificios tornillo 3.5

Locking plate 22 holes 3.5mm screws



Placas bloqueadas de sostén estrechas 3.5mm *Butress narrow locking plate 4.0/3.5mm*
Ancho/ *Width 10.2mm* Grosor/ *Thickness 4.0/3.5mm*

PB3535-E100

Longitud 100mm

Length 100mm



PB3535-E120

Longitud 120mm

Length 120mm



PB3535-E140

Longitud 140mm

Length 140mm



PB3535-E160

Longitud 160mm

Length 160mm



Placas bloqueadas de sostén anchas 4.0/3.5mm *Butress broad locking plate 4.0/3.5mm*
Ancho/*Width 12mm* Grosor/ *Thickness 4.0mm*

PB3535-A100

Longitud 100mm

Length 100mm



PB3535-A120

Longitud 120mm

Length 120mm



PB3535-A140

Longitud 140mm

Length 140mm



PB3535-A160

Longitud 160mm

Length 160mm



PB3535-A180

Longitud 180mm

Length 180mm



Placas bloqueadas fracturas distales de fémur *Locking plates for distal femoral fractures*
 Grosor / *Thickness* 4.0/3.5mm

PBFD-35L

Placa bloqueada larga fémur derecho
Right long femoral locking plate
 Longitud/ *length* 12 cm



PBFI-35L

Placa bloqueada larga fémur izquierdo
Left long femoral locking plate



PBFD-35C

Placa bloqueada corta fémur derecho
Right short femoral locking plate
 Longitud/ *length* 11 cm



PBFI-35C

Placa bloqueada corta fémur izquierdo
Left shot femoral locking plate



Otras placas bloqueadas para fracturas supracondilares de fémur
Other supracondylar femoral fractures locking plates

PBFED-35E

Placa bloqueada fémur estrecha derecha curvada
 Longitud/*Length*: 105mm
 Grosor/*Thickness*: 4.0/3.5mm
 Ancho/*Width*: 10mm



PBFEI-35E

Placa bloqueada fémur izdo curvada
 Longitud/*Length*: 105mm
 Grosor/*Thickness*: 4.0/3.5mm
 Ancho/*Width*: 10mm



Placa bloqueada ancha supracondilar fémur
Locking supracondylar femoral plate

PBFED-35A

Dcha/*right*

PBF EI-35A

Izda/*left*

Longitud/*Length*: 137mm
 Grosor/*Thickness*: 4.0mm
 Ancho/*Width*: 12.5m

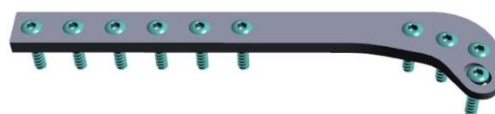

Placas bloqueadas para la osteotomía craneal de la tibia y otras aplicaciones
Locking cobra plates for CTWO

PBTPLO-3

Longitud/*Length* 67
Cabeza/*Width of T head* 18
Cola/*width plate shaft* 12
Grosor/*Thikness* 4.0/3.5

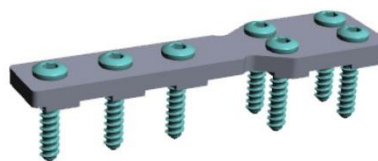

PBTPLO-4

Longitud/*Length* 79
Cabeza/*Width of T head* 18
Cola/*width plate shaft* 12
Grosor/*Thikness* 4.0/3.5

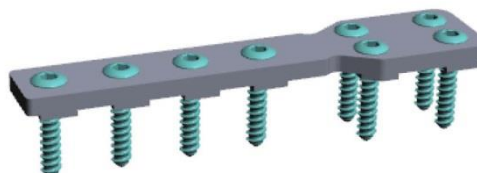

PBTPLO-5

Longitud/*Length* 92
Cabeza/*Width of T head* 18
Cola/*width plate shaft* 12
Grosor/*Thikness* 4.0/3.5

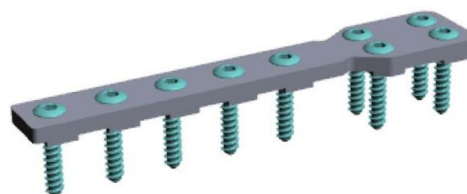

PBT-35

Placa bloqueada en T para fracturas distales de radio
T-locking plate for distal radial fractures
Longitud / *Length* 80mm
Ancho cabeza / *Width of T head* 18.0mm
Ancho cola / *Width plate shaft* 11.0mm
Grosor / *Thickness* 4.0mm

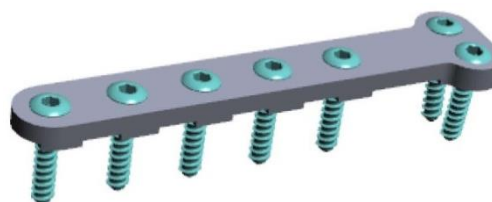

PBT-35C

Placa bloqueada en T corta *Low contact short Tplate*
Longitud / *Length* 55mm
Ancho cabeza / *Width of T head* 22mm
Ancho cola / *Width plate shaft* 10mm
Grosor / *Thickness* 4.0mm

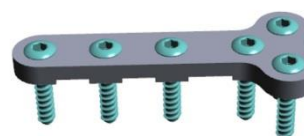

PBT-35L

Placa bloqueada en T larga
Low contact long T-locking plate
Ancho cabeza / *Width of T head* 24mm
Ancho cola / *Width plate shaft* 12mm
Longitud / *Length* 80mm

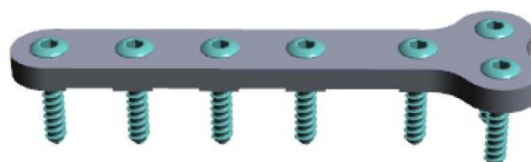

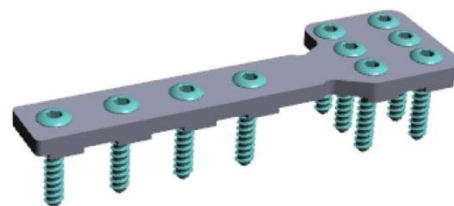
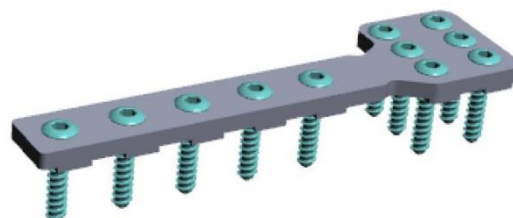
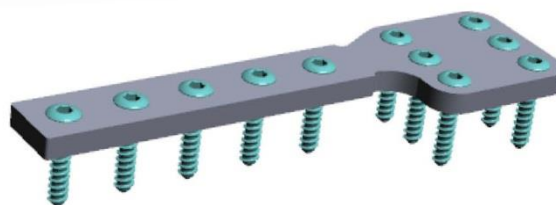
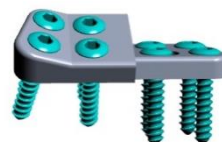
PBTPLO-D4Dcha/*right*Longitud/*Length 80mm*Cabeza/*width T head 24mm*Grosor/*Thickness 4.0/3.5mm*Cola/*width plate shaft 12mm***PBTPLO-I4**izda/*left***PBTPLO-D5**Dcha/*right*Longitud/*Length 92mm***PBTPLO-I5**izda/*left***PBTPLO-DG**Dcha/*right*Longitud/*Length 110mm*Cabeza/*width T head 28mm*Grosor/*Thickness 4.0 mm*Cola/*width plate shaft 13mm***PBTPLO-IG**izda/*left***PBACET-35** Placa acetabular*Acetabular plate*Grosor/*Thickness 4.0/2.5mm***PBDPO-25D** Locking plate DPO 25° right**PBDPO-25I** Locking plate DPO 25° left**PBDPO-35D** Locking plate DPO 35° right**PBDPO-35I** Locking plate DPO 35° left**GBPB-2532**

Guía broca placas bloqueadas broca 2.5-3.2mm

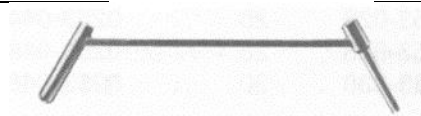
Drill guide locking plate drill 2.5-3.2

PLACAS PARA TORNILLOS DE 4.5 MM DE DIAMETRO PLATES FOR 4.5 MM SCREW DIAMETER

Placas estrechas DCP 4.5mm
Ancho 12mm Grosor 4mm

4.5mm narrow DCP plates
Width 12mm Thickness 4.0mm



Referencia <i>Reference</i>	Longitud <i>Length</i>	Orificios <i>Holes</i>	Referencia <i>Reference</i>	Longitud <i>Length</i>	Orificios <i>Holes</i>
4545-E04	71mm	4	4545-E12	199mm	12
4545-E05	87mm	5	4545-E13	216mm	13
4545-E06	103mm	6	4545-E14	231mm	14
4545-E07	119mm	7	4545-E15	247mm	15
4545-E08	135mm	8	4545-E16	263mm	16
4545-E09	151mm	9	4545-E17	279mm	17
4545-E10	167mm	10	4545-E18	195mm	18
4545-E11	183mm	11			

Placas estrechas LC-DCP 4.5mm **4.5mm narrow LC-DCP plates**

Ancho 12mm Grosor 4mm
Width 12mm Thickness 4.0mm



Referencia <i>Reference</i>	Longitud <i>Length</i>	Orificios <i>Holes</i>	Referencia <i>Reference</i>	Longitud <i>Length</i>	Orificios <i>Holes</i>
4545-LC06	106mm	6	4545-LC12	214mm	12
4545-LC07	124mm	7	4545-LC13	232mm	13
4545-LC08	142mm	8	4545-LC14	250mm	14
4545-LC09	160mm	9	4545-LC15	266mm	15
4545-LC10	178mm	10	4545-LC16	286mm	16
4545-LC11	196mm	11			

Placas anchas DCP 4.5mm
Ancho 16.5mm Grosor 4.8mm

4.5mm broad DCP plates
Width 16.5mm Thickness 4.8mm



Referencia <i>Reference</i>	Longitud <i>Length</i>	Orificios <i>Holes</i>	Referencia <i>Reference</i>	Longitud <i>Length</i>	Orificios <i>Holes</i>
4545-A05	87mm	5	4545-A12	199mm	12
4545-A06	103mm	6	4545-A13	216mm	13
4545-A07	119mm	7	4545-A14	231mm	14
4545-A08	135mm	8	4545-A15	247mm	15
4545-A09	151mm	9	4545-A16	263mm	16
4545-A10	167mm	10	4545-A17	279mm	17
4545-A11	183mm	11	4545-A18	195mm	18

Placas anchas orificio redondo 4.5mm
 Ancho 16.5mm Grosor 4.8mm
4.5mm broad round holes plates
Width 16.5mm Thickness 4.8mm



Referencia	Longitud	Orificios	Referencia	Longitud	Orificios
<i>Reference</i>	<i>Length</i>	<i>Holes</i>	<i>Reference</i>	<i>Length</i>	<i>Holes</i>
4545-R05	87mm	5	4545-R12	199mm	12
4545-R06	103mm	6	4545-R13	216mm	13
4545-R07	119mm	7	4545-R14	231mm	14
4545-R08	135mm	8	4545-R15	247mm	15
4545-R09	151mm	9	4545-R16	263mm	16
4545-R10	167mm	10	4545-R17	279mm	17
4545-R11	183mm	11	4545-R18	195mm	18

Tornillos cortical Ø 4.5mm
 Paso de rosca 1.75mm
Ø 4.5 mm cortical screws
Pitch of thread 1.75mm



Referencia	Longitud	Referencia	Longitud	Referencia	Longitud
<i>Reference</i>	<i>Length</i>	<i>Reference</i>	<i>Length</i>	<i>Reference</i>	<i>Length</i>
0045-010	10 mm	0045-026	26 mm	0045-042	42 mm
0045-012	12mm	0045-028	28 mm	0045-044	44 mm
0045-014	14 mm	0045-030	30 mm	0045-046	46 mm
0045-016	16 mm	0045-032	32 mm	0045-048	48 mm
0045-018	18 mm	0045-034	34 mm	0045-050	50 mm
0045-020	20 mm	0045-036	36 mm	0045-052	52 mm
0045-022	22 mm	0045-038	38 mm	0045-054	54 mm
0045-024	24 mm	0045-040	40 mm	0045-056	56 mm

Tornillo maleolar Ø 4.5mm
 Paso de rosca 1.75mm
Ø 4.5 mm maleolar screws
Pitch of thread 1.75mm



Referencia	Longitud	Referencia	Longitud	Referencia	Longitud
<i>Reference</i>	<i>Length</i>	<i>Reference</i>	<i>Length</i>	<i>Reference</i>	<i>Length</i>
0046-025	25 mm	0046-040	40 mm	0046-055	55 mm
0046-030	30 mm	0046-045	45 mm	0046-060	60 mm
0046-035	35 mm	0046-050	50 mm	0046-065	65 mm

Tornillos esponjosa Ø 6.5mm Rosca Completa
 Paso de rosca 1.75mm
Ø 6.5 mm cancellous full thread screws
Pitch of thread 1.75mm



Referencia	Longitud	Referencia	Longitud	Referencia	Longitud
<i>Reference</i>	<i>Length</i>	<i>Reference</i>	<i>Length</i>	<i>Reference</i>	<i>Length</i>
0065-025	25 mm	0065-045	45 mm	0065-065	65 mm
0065-030	30 mm	0065-050	50 mm	0065-070	70 mm
0065-035	35 mm	0065-055	55 mm	0065-075	75 mm
0065-040	40 mm	0065-060	60 mm	0065-080	80 mm

Tornillos esponjosa Ø 6.5 mm rosca parcial de 16mm



Ø 6.5 mm cancellous screw partially threaded 16mm

Referencia	Longitud	Referencia	Longitud	Referencia	Longitud
<i>Reference</i>	<i>Length</i>	<i>Reference</i>	<i>Length</i>	<i>Reference</i>	<i>Length</i>
0067-025	25 mm	0067-045	45 mm	0067-065	65 mm
0067-030	30 mm	0067-050	50 mm	0067-070	70 mm
0067-035	35 mm	0067-055	55 mm	0067-075	75 mm
0067-040	40 mm	0067-060	60 mm	0067-080	80 mm

Tornillos esponjosa Ø 6.5 mm rosca parcial de 32mm

Ø 6.5 mm cancellous screw partially threaded 32mm

Referencia	Longitud	Referencia	Longitud
<i>Reference</i>	<i>Length</i>	<i>Reference</i>	<i>Length</i>
0066-045	45 mm	0066-060	60 mm
0066-050	50 mm	0066-065	65 mm
0066-055	55 mm	0066-070	70 mm



Placas sostén 4.5mm orificios redondos (utilizar la guía del broca GBPB-2532)
4.5mm Butress plates (Use the drill guide 449-2532)

Ancho 12mm Grosor 4.0mm **Width 12mm Thickness 4.0mm**

4545-100

Longitud/*Length* 100mm

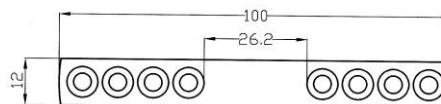

4545-120

Longitud/*Length* 120mm

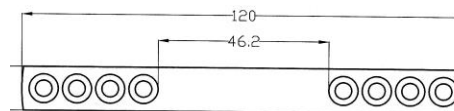

4545-140

Longitud/*Length* 140mm

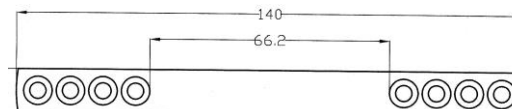

4545-160

Longitud/*Length* 160mm

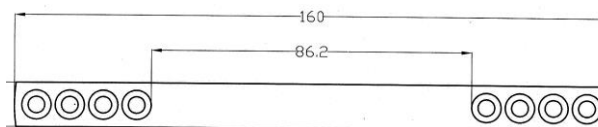

4545-180

Longitud/*Length* 180mm

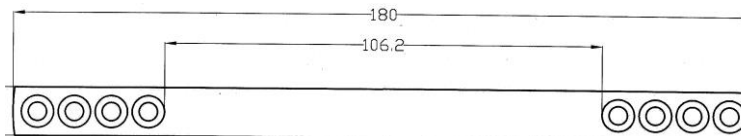

GDCP-45

Guía de broca placas DCP 4.5 mm

4.5mm cortex screws drill guide DCP plates



GD-3245

Guía de broca dentada doble 3.2-4.5
Indented 3.2/4.5 mm double drill sleeve

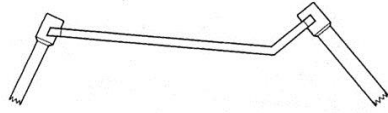

PM-45

Pasamachos anclaje rápido 4.5mm
4.5mm tap with quick fit



PM-45T

Pasamachos 4.5mm con mango
Tap 4.5 mm with handle

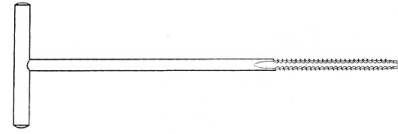

AV-32

Avellanador punta 3,2 mm
Countersink 3,2mm point

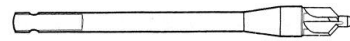

AV-32T

Avellanador mango T punta 3,2mm
Countersink T-handle 3,2mm point

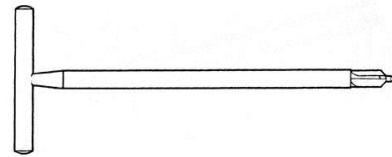

AT-45

Atornillador de anclaje rápido 4.5-6.5mm
4.5-6.5mm screw driver with quick fit

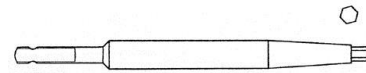

AT-45M

Atornillador 4.5-6.5mm con mango y sin pinza
4.5-6.5mm Screw driver with handle without forceps

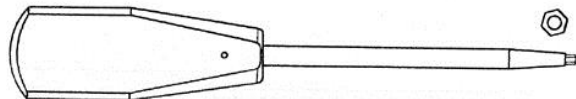
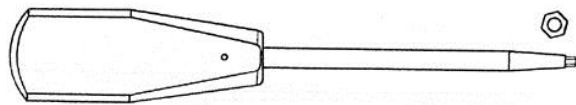

AT-45M

Atornillador 4.5-6.5mm con mango y pinza
4.5-6.5mm Screw driver with handle and forceps

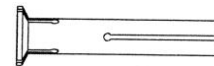

CP-45

Guía centradora broca diámetro 4.5mm
Ø 4.5 mm pointed drill guide

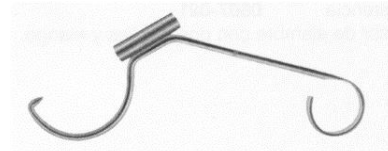

C-4532

Casquillo 4.5mm broca 3.2mm
Drill guide external diameter 4.5mm drill 3.2mm

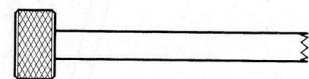

MT-45

Medidor de longitud tornillos 4.5 mm
Depth gauge for 4.5 mm screws



PLACAS BLOQUEADAS Ø 4.5 mm
LOCKING PLATES 4.5 Ø SCREWS



PB45RC-025

Placa de reconstrucción bloqueada 4.5mm 16 orificios

4.5mm cut-to-length reconstruction locking plate 16 holes Longitud /Length 300mm

Ancho/ Width 14 mm Grosor/ Thickness 5.0/4.3mm

PB45RC-025A

Placa de reconstrucción bloqueada 4.5mm 20 orificios

4.5mm reconstruction locking plate 20 holes

Longitud /Length 300 mm Ancho/ Width 16 mm Grosor/ Thickness 5.0/4.3mm



Placas 4.5mm sostén bloqueadas 4.5mm Butress locking plates

Ancho/ Width 12mm Grosor/Thickness 5.0/4.0mm

PB4545-100

Longitud/Length 100mm



PB4545-120

Longitud/Length 120mm



PB4545-140

Longitud/Length 140mm



PB4545-160

Longitud/Length 160mm



PB4545-180

Longitud/Length
180mm



A-13

Arandelas 13 mm diámetro tornillos 6.5mm y cortical 4.5 mm

Washer 13 mm diameter for 6.5 and 4.5 mm screws



GBP-2532

Guía broca placas bloqueadas brocas 2.5-3.2mm

Drill guide locking plate drills 2.5-3.2mm

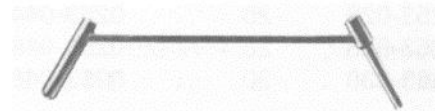

PLACAS TRIPLE OSTEOTOMIA DE CADERA TRIPLE PELVIC OSTEOTOMY PLATES

2582-012

Placa Miami de 24° derecha 10 orificios.

Miami plate 10 holes 24° right



2582-112

Placa Miami de 24° izquierda 10 orificios.

Miami plate 10 holes 24° left



Placas triple osteotomía de cadera
Triple pelvic osteotomy plates

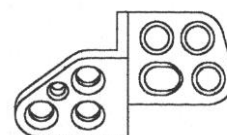
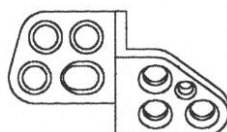

2581-027

Placa 25° izquierda tornillo 2.7mm

TPO left plate 25° / 2.7 mm screws

2580-027

Placa 25° derecha tornillo 2,7 mm

TPO right plate 25° / 2.7 mm screws

2581-020

Placa 20° izquierda tornillo 3.5 mm

TPO left plate 20° / 3.5 mm screws

2580-020

Placa 20° derecha tornillo 3.5 mm

TPO right plate 20° / 3.5 mm screws

2581-030

Placa 30° izquierda tornillo 3.5 mm

TPO left plate 30° / 3.5 mm screws

2580-030

Placa 30° derecha tornillo 3.5 mm

TPO right plate 30° / 3.5 mm screws

2581-040

Placa 40° izquierda tornillo 3.5 mm

TPO left plate 40° / 3.5 mm screws

2580-040

Placa 40° derecha tornillo 3.5 mm

TPO right plate 40° / 3.5 mm screws

Placas bloqueo doble osteotomía torn 3.5mm

Locking double pelvic osteotomy plates 3.5

Locking triple pelvic osteotomy plates

PB2582-012 Miami plate 24° right

PB2582-112 Miami plate 24° left

PBDPO-25D 25° dcha/right

PBDPO-25I 25° izda/left

PBDPO-35D 35° dcha/right

PBDPO-35I 35° izda/left

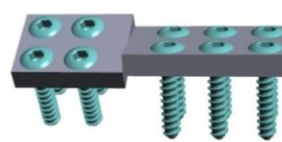
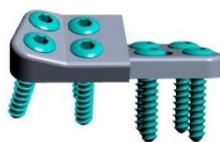

Placa síndrome compartimento medial del codo

Medial compartment disease plates 3.5mm screws

Total length 70mm; Step 3mm

MCD-02



PBMCD-02

Locking plates



PLACAS HIBRIDAS DE PANARTRODESIS DE TARSO

HYBRID PLATES FOR TARSAL PANARTHRODESIS



T35-035D Placa panartrodesis tarso lateral derecho. Tornillo proximal 3.5mm distal 3.5mm
Right lateral tarsal panarthrodesis plate proximal screw 3.5mm distal 3.5mm

T35-035I Placa panartrodesis tarso lateral izquierdo. Tornillo proximal 3.5mm distal 3.5mm
Left lateral tarsal panarthrodesis plate proximal screw 3.5mm distal 3.5mm

T30-27D Placa panartrodesis tarsal derecha. Tornillo proximal 3.5mm distal 2.7mm
Right lateral tarsal panarthrodesis plate proximal screw 3.5mm distal 2.7mm

T30-27I Placa panartrodesis tarsal izquierda. Tornillo proximal 3.5mm distal 2.7mm
Left lateral tarsal panarthrodesis plate proximal screw 3.5mm distal 2.7mm

T35-027D Placa panartrodesis tarso lateral derecho. Tornillo proximal 3.5mm distal 2.7mm
Right lateral tarsal panarthrodesis plate proximal screw 3.5mm distal 2.7mm

T35-027I Placa panartrodesis tarso lateral izquierdo. Tornillo proximal 3.5mm distal 2.7mm
Left lateral tarsal panarthrodesis plate proximal screw 3.5mm distal 2.7mm

T27-020D Placa panartrodesis tarso lateral derecho. Tornillo proximal 2.7mm distal 2.0mm
Right lateral tarsal panarthrodesis plate proximal screw 2.7mm distal 2.0mm

T27-020I Placa panartrodesis tarso lateral izquierdo. Tornillo proximal 2.7mm distal 2.0mm
Left lateral tarsal panarthrodesis plate proximal screw 2.7mm distal 2.0mm

T20-020D Placa panartrodesis tarso lateral derecho. Tornillo proximal 2.0mm distal 2.0mm
Right lateral tarsal panarthrodesis plate proximal screw 2.0mm distal 2.0mm

T20-020I Placa panartrodesis tarso lateral izquierdo. Tornillo proximal 2.0mm distal 2.0mm
Right lateral tarsal panarthrodesis plate proximal screw 2.0mm distal 2.0mm

T20-015D Panartrodesis tarso lateral derecho. Tornillo proximal 2.0mm distal 1.5mm
Right lateral tarsal panarthrodesis plate proximal screw 2.0mm distal 1.5mm

T20-015I Panartrodesis tarso lateral izquierdo. Tornillo proximal 2.0mm distal 1.5mm
Left lateral tarsal panarthrodesis plate proximal screw 2.0mm distal 1.5mm

PLACAS PARA LA OSTEOTOMÍA TIBIAL CRANEAL EN CUÑA PLATES FOR CRANIAL TIBIAL WEDGE OSTEOTOMY

TPLO-20

Longitud / *Length* 39.0mm
Cabeza / *width of T head* 10mm
Cola / *width plate shaft* 6.0mm
Grosor / *thickness* 2.0mm



TPLO-24

Longitud / *Length* 42,50mm
Cabeza / *width of T head* 12 mm
Cola / *width plate shaft* 6.5mm
Grosor / *thickness* 2.5mm

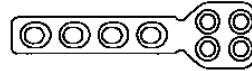

TPLO-27C

Longitud / *Length* 48.0mm
Cabeza / *width of T head* 14mm
Cola / *width plate shaft* 8.0mm
Grosor / *thickness* 2.5mm

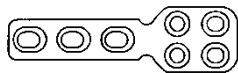

TPLO-27L

Longitud / *Length* 59.0mm
Cabeza / *width of T head* 16mm
Cola / *width plate shaft* 10.0mm
Grosor / *thickness* 2.5mm



TPLO-27G

Longitud / *Length* 66mm
Cabeza / *width of T head* 17mm
Cola / *width plate shaft* 11mm
Grosor / *thickness* 2.5mm

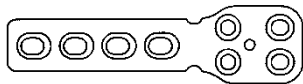

TPLO-3

Longitud / *Length* 67mm
Cabeza / *width of T head* 18mm
Cola / *width plate shaft* 12mm
Grosor / *thickness* 3.0mm

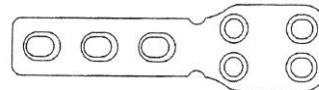

TPLO-4

Longitud / *Length* 79mm
Cabeza / *width of T head* 18mm
Cola / *width plate shaft* 12mm
Grosor / *thickness* 3.0mm

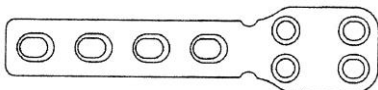

TPLO-5

Longitud / *Length* 92mm
Cabeza / *width of T head* 18mm
Cola / *width plate shaft* 12mm
Grosor / *thickness* 3.0mm

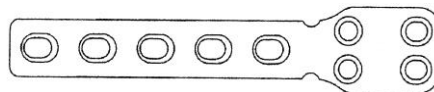

Placas bandera *Flag tibial plates*

Cabeza/*width T head* 24mm
 Cola/*width plate shaft* 12mm
 Grosor/*Thickness* 3mm

	Longitud/ Length
TPLO-D3 Placa bandera derecha torn 3.5 mm 3 orif distales <i>Right flag plate 3.5 mm screw 3 holes</i>	67mm
TPLO-I3 Placa bandera izquierda torn 3.5 mm 3 orif distales <i>Left flag plate 3.5 mm screw 3 holes</i>	67mm
TPLO-D4 Placa bandera derecha torn 3.5 mm 4 orif distales <i>Right flag plate 3.5 mm screw 4 holes</i>	80mm
TPLO-I4 Placa bandera izquierda torn 3.5 mm 4 orif distales <i>Left flag plate 3.5 mm screw 4 holes</i>	80mm
TPLO-D5 Placa bandera derecha torn 3.5 mm 5 orif distales <i>Right flag plate 3.5 mm screw 5 holes</i>	92mm
TPLO-I5 Placa bandera izquierda torn 3.5 mm 5 orif distales <i>Left flag plate 3.5 mm screw 5 holes</i>	92mm

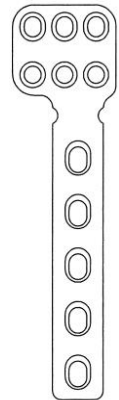

Cabeza/*width T head* 28mm Cola/*width plate shaft* 13mm
 Grosor/*Thickness* 4mm Longitud/*Length* 110mm

TPLO-DG Placa bandera especial grande dcha torn 3.5 mm 5 orificios <i>Special right big flag plate 3.5 mm screw 5 holes</i>
TPLO-IG Placa bandera especial grande izda torn 3.5 mm 5 orificios <i>Special left big flag plate 3.5 mm screw 5 holes</i>
TPLO-D45 Placa bandera gigante dcha tornillo 4.5 o 6.5 mm 5 orificios <i>Gigant right flag plate 4.5 or 6.5 mm screw 5 holes</i>
TPLO-I45 Placa bandera gigante izda tornillo 4.5 o 6.5 mm 5 orificios <i>Gigant left flag plate 4.5 or 6.5 mm screw 5 holes</i>

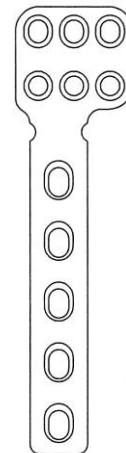

Placas para la osteotomía de nivelación del plateau tibial *Plates tibial plateau leveling osteotomy*

SLOC-D27 **SLOC-I27**
SLOC-D3 **SLOC-I3**
SLOC-D4 **SLOC-I4**

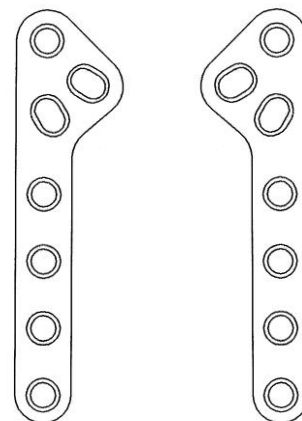

Placas cobra y bandera bloqueadas *Locking cobra and flag tibial plates*

PBTPL0-20

Longitud / *Length* 39.0mm
 Cabeza / *width of T head* 10mm
 Cola / *width plate shaft* 6.0mm
 Grosor / *thickness* 2.5mm



PBTPL0-24

Longitud / *Length* 42,50mm
 Cabeza / *width of T head* 12 mm
 Cola / *width plate shaft* 6.5mm
 Grosor / *thickness* 2.5mm



PBTPL0-27C

Longitud / *Length* 48.0mm
 Cabeza / *width of T head* 14mm
 Cola / *width plate shaft* 8.0mm
 Grosor / *thickness* 3.0/2.5mm



PBTPL0-27L

Longitud / *Length* 59.0mm
 Cabeza / *width of T head* 16mm
 Cola / *width plate shaft* 10.0mm
 Grosor / *thickness* 3.0/2.5mm

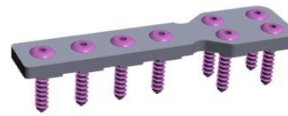

PBTPL0-27G

Longitud / *Length* 66mm
 Cabeza / *width of T head* 16mm
 Cola / *width plate shaft* 10.0mm
 Grosor / *thickness* 3.0/2.5mm

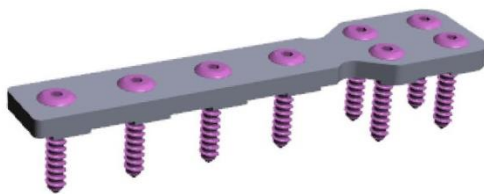

PBTPL0-3

Longitud/*Length* 67
 Cabeza/*Width of T head* 18
 Cola/*width plate shaft* 12
 Grosor/*Thikness* 4.0/3.5

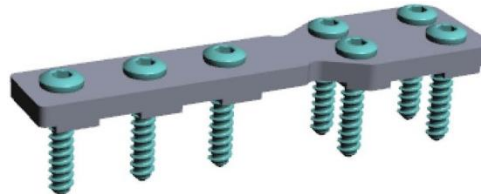

PBTPL0-4

Longitud/*Length* 79
 Cabeza/*Width of T head* 18
 Cola/*width plate shaft* 12
 Grosor/*Thikness* 4.0/3.5



PBTPL0-5

Longitud/*Length* 92
 Cabeza/*Width of T head* 18
 Cola/*width plate shaft* 12
 Grosor/*Thikness* 4.0/3.5



PBTPL0-D4 **PBTPL0-I4**

Dcha/*right* izda/*left*
 Longitud/*Length* 80mm
 Cabeza/*width T head* 24mm
 Grosor/*Thickness* 4.0/3.5mm
 Cola/*width plate shaft* 12mm

PBTPL0-D5 **PBTPL0-I5**

Dcha/*right* izda/*left*
 Longitud/*Length* 92mm



PBTPL0-DG **PBTPL0-IG**

Dcha/*right* izda/*left*
 Longitud/*Length* 110mm
 Cabeza/*width T head* 28mm



Técnica extracapsular rotura LCA
ACL Extracapsular technique

TEN-CAS

Tensor del nylon(distractor)
Nylon distractor



Detalle de la cabeza del tensor por donde
pasa el nylon
Head of the distractor where de nylon cross

AL-CAS



Detalle de la punta del alicate

Alicatede compresión de los casquillos
Forceps
Head of the forceps

CAS-NYP

Casquillo redondo sujeta nylon



CAS-NYP

Casquillo aplanado sujeta nylon



ET-1520: extractor tornillos 1.5-2.0mm

ET-2735: extractor tornillos 2.7-3.5mm

ET-45: extractor tornillos 4.5mm



Anclaje **2.5mm** orificio cabeza 1.2mm
AC25-010 Anclaje 2.5mm 10mm longitud
AC25-015 Anclaje 2.5mm 15mm longitud

Anclaje **3.0mm** orificio cabeza 1.5mm
AC30-015 Anclaje 3.0mm 15mm longitud
AC30-020 Anclaje 3.0mm 20mm longitud
AC30-025 Anclaje 3.0mm 25mm longitud

Anclaje **4.0mm** orificio cabeza 2.0mm
AC40-020 Anclaje 3.0mm 15mm longitud
AC40-025 Anclaje 3.0mm 20mm longitud
AC40-030 Anclaje 3.0mm 25mm longitud



INSTRUMENTAL y CUÑAS DE TITANIO POROSO

DIS-TTA

Distractor para TTA
TTA distractor



CTP-3: Cuña titanio poroso 3mm



GS-TTA

Guía de hoja sierra



CTP-4.5: Cuña titanio poroso 4.5mm



CTP-BG Base guía



CTP-6: Cuña titanio poroso 6.0mm

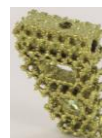

CTP-V Varillas



CTP-7.5: Cuña titanio poroso 7.5 mm

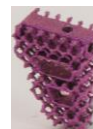

CTP-P Perno



CTP-9: Cuña titanio poroso 9.0mm

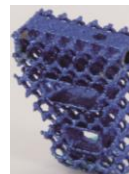

CTP-PA

Plantilla agujas

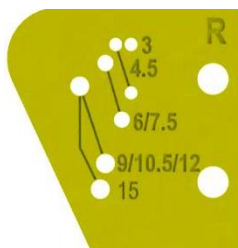

CTP-10.5: Cuña titanio poroso 10.5mm

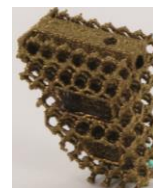

CTP-CI Conjunto instrumental
(base guía, 2 varillas,
perno y plantilla
agujas)

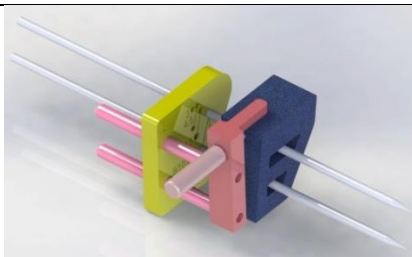

CTP-12: Cuña titanio poroso 12mm



CTP-15: Cuña titanio poroso 15mm

PLACAS BRAZO INCLINADO TTA DE ACERO Y SUS CAJAS
S.S. TTA ARM TILT PLATES AND THEIR CAGES

ATT-BI1
 Placa TTA n°1
TTA plate 1

S-3-7D 3.0mm x 7.0mm

S-3-10D 3.0mm x 10mm

ATT-BI2
 Placa TTA n°2
TTA plate 2

S-4.5-9D 4.5mm x 9.0mm

S-4.5-12D 4.5mm x 12mm

ATT-BI3
 Placa TTA n°3
TTA plate 3

S-6-16D 6.0mm x 16mm

S-6-19D 6.0mm x 19mm

ATT-BI4
 Placa TTA n°4
TTA plate 4

S-7.5-16D 7.5mm x 16mm

S-7.5-19D 7.5mm x 19mm

ATT -BI5
 Placa TTA n°5
TTA plate 5

S-9-19D 9.0mm x 19mm

S-9-22D 9.0mm x 22mm

ATT-BI6
 Placa TTA n°6
TTA plate 6

S-10.5-19D 10.5mm x 19mm

S-10.5-22D 10.5mm x 22mm

ATT-BI7
 Placa TTA n°7
TTA plate 7

S-12-22D 12mm x 22mm

S-12-25D 12mm x 25mm

ATT-BI8
 Placa TTA n°8
TTA plate 8

S-15-25D 15mm x 25mm

S-15-28D 15mm x 28mm

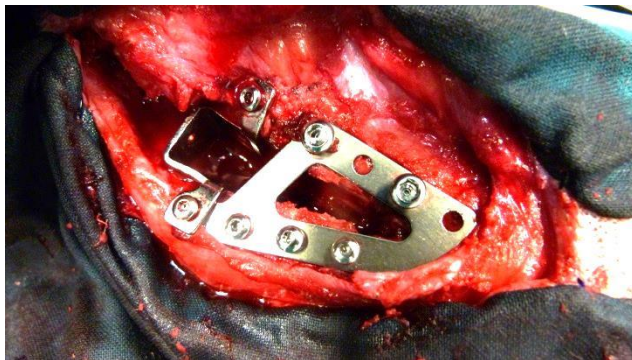

PLACAS TTA BRAZO INCLINADO Y CAJAS TTA TITANIO
TITANIUM TTA ARM TILT PLATES AND THEIR CAGES

TTT-BI1
 Placa TTA n°1
TTA plate 1

TS-3-7D 3.0mm x 7.0mm

TS-3-10D 3.0mm x 10mm

TTT-BI2
 Placa TTA n°2
TTA plate 2

TS-4.5-9D 4.5mm x 9.0mm

TS-4.5-12D 4.5mm x 12mm

TTT-BI3
 Placa TTA n°3
TTA plate 3



TS-6-16D 6.0mm x 16mm

TS-6-19D 6.0mm x 19mm

TTT-BI4
 Placa TTA n°4
TTA plate 4

TS-7.5-16D 7.5mm x 16mm

TS-7.5-19D 7.5mm x 19mm

TTT -BI5
 Placa TTA n°5
TTA plate 5



TS-9-19D 9.0mm x 19mm

TS-9-22D 9.0mm x 22mm

TTT-BI6
 Placa TTA n°6
TTA plate 6

TS-10.5-19D 10.5mm x 19mm

TS-10.5-22D 10.5mm x 22mm

TTT-BI7
 Placa TTA n°7
TTA plate 7

TS-12-22D 12mm x 22mm

TS-12-25D 12mm x 25mm

TTT-BI8
 Placa TTA n°8
TTA plate 8

TS-15-25D 15mm x 25mm



BANDEJA PARA ATT BRAZO INCLINADO Y SUS CAJAS
TRAY FOR TTA PLATES ARM TILT AND THEIR CAGES

BJ-TTA Bandeja TTAs
TTA's tray

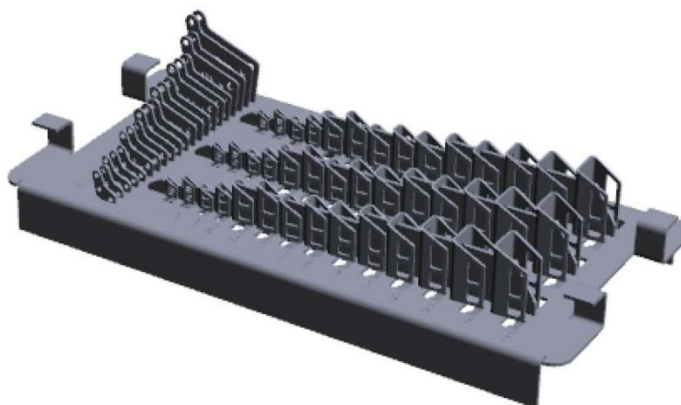

PLACAS TTA ASIMETRICAS ASIMETRIC TTA PLATES

Combinación de caja y placa *Combination of cage and plate*

S-3-7P1D S-3-7P1I

Cage 3x10mm right izda/*left*

Plate 1

S-4.5-10P2D S-4.5-10P2I

Cage 4.5x10mm right izda/*left*

Plate 2

S-4.5-12P3D S-4.5-12P3I

Cage 4.5x12mm right izda/*left*

Plate 3

S-6-14P4D S-6-14P4I

Cage 6.0x14mm right izda/*left*

Plate 4

S-6-16P5D S-6-16P5I

Cage 6.0x14mm right izda/*left*

Plate 5

S-7.5-16P4D S-7.5-16P4I

Cage 7.5x16mm right izda/*left*

Plate 4

S-7.5-16P5D S-7.5-16P5I

Cage 7.5x16mm right izda/*left*

Plate 5

S-9.0-19P5D S-9.0-19P5I

Cage 9.0x19mm right izda/*left*

Plate 5

S-9.0-19P6D S-9.0-19P6I

Cage 9.0x19mm right izda/*left*

Plate 6

S-10.5-19P5D S-10.5-19P5I

Cage 10.5x19mm right izda/*left*

Plate 5

S-10.5-19P6D S-10.5-19P6I

Cage 10.5x19mm right izda/*left*

Plate 6

S-12-22P6D S-12-22P6I

Cage 12x22mm right izda/*left*

Plate 6

S-12-22P7D S-12-22P7I

Cage 12x22mm right izda/*left*

Plate 7

S-15-25P8D S-15-25P8I

Cage 15x25mm right izda/*left*

Plate 8

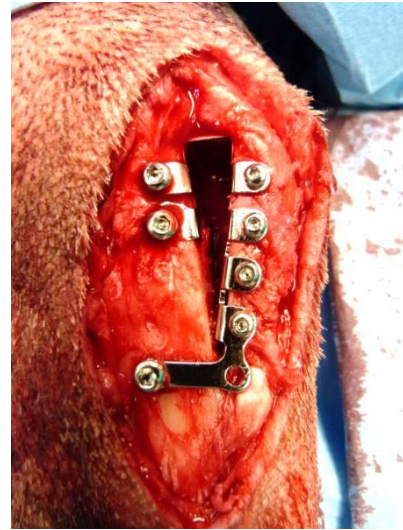

PUENTES *BRIDGES*

P-6 Bridge 6.0mm

P-9 Bridge 9.0mm

P-12 Bridge 12.0mm

P-15 Bridge 15.0mm

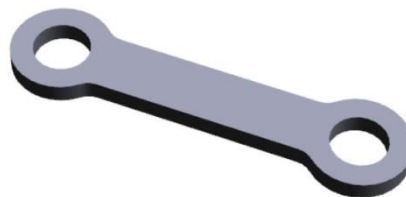

TORNILLOS TITANIO PARA ATTs DE TITANIO TITANIUM SCREWS FOR ATTs OF TITANIUM

Tornillos cortical de titanio Ø 2.0 mm autoroscantes
Titanium cortical self-taping screws Ø 2.0 mm

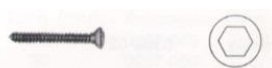

Referencia <i>Reference</i>	Longitud <i>Length</i>	Referencia <i>Reference</i>	Longitud <i>Length</i>	Referencia <i>Reference</i>	Longitud <i>Length</i>
TA20-006	6 mm	TA20-018	18 mm	TA20-030	30 mm
TA20-008	8 mm	TA20-020	20 mm	TA20-032	32 mm
TA20-010	10 mm	TA20-022	22 mm	TA20-034	34 mm
TA20-012	12 mm	TA20-024	24 mm	TA20-036	36 mm
TA20-014	14 mm	TA20-026	26 mm	TA20-038	38 mm
TA20-016	16 mm	TA20-028	28 mm	TA20-040	40 mm

Tornillos cortical de titanio Ø 2.4 mm autoroscantes
Titanium cortical self-taping screws Ø 2.4 mm



Referencia <i>Reference</i>	Longitud <i>Length</i>	Referencia <i>Reference</i>	Longitud <i>Length</i>	Referencia <i>Reference</i>	Longitud <i>Length</i>
TA24-006	6 mm	TA24-018	18 mm	TA24-030	30 mm
TA24-008	8 mm	TA24-020	20 mm	TA24-032	32 mm
TA24-010	10 mm	TA24-022	22 mm	TA24-034	34 mm
TA24-012	12 mm	TA24-024	24 mm	TA24-036	36 mm
TA24-014	14 mm	TA24-026	26 mm	TA24-038	38 mm
TA24-016	16 mm	TA24-028	28 mm	TA24-040	40 mm

Tornillos cortical de titanio Ø 2.7 mm autoroscantes
Titanium cortical self-taping screws Ø 2.7 mm

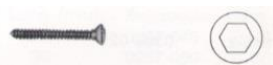

Referencia <i>Reference</i>	Longitud <i>Length</i>	Referencia <i>Reference</i>	Longitud <i>Length</i>	Referencia <i>Reference</i>	Longitud <i>Length</i>
TA27-006	6 mm	TA27-018	18 mm	TA27-030	30 mm
TA27-008	8 mm	TA27-020	20 mm	TA27-032	32 mm
TA27-010	10 mm	TA27-022	22 mm	TA27-034	34 mm
TA27-012	12 mm	TA27-024	24 mm	TA27-036	36 mm
TA27-014	14 mm	TA27-026	26 mm	TA27-038	38 mm
TA27-016	16 mm	TA27-028	28 mm	TA27-040	40 mm

Tornillos de Titanio Ø 3.5 mm
Titanium screws Ø 3.5 mm

Referencia <i>Reference</i>	Longitud <i>Length</i>	Referencia <i>Reference</i>	Longitud <i>Length</i>	Referencia <i>Reference</i>	Longitud <i>Length</i>
TI35-010	10 mm	TI35-022	22 mm	TI35-034	34 mm
TI35-012	12 mm	TI35-024	24 mm	TI35-036	36 mm
TI35-014	14 mm	TI35-026	26 mm	TI35-038	38 mm
TI35-016	16 mm	TI35-028	28 mm	TI35-040	40 mm
TI35-018	18 mm	TI35-030	30 mm	TI35-045	45 mm
TI35-020	20 mm	TI35-032	32 mm	TI35-050	50 mm

PLACAS HIBRIDAS PANARTRODESIS CARPAL RECTAS

HYBRID PLATES FOR CARPAL PANARTHRODESIS STRAIGHT

Placas híbridas rectas panartrodesis carpal
Straight hybrid plates for carpal panarthrodesis

P35-035L

Tornillos 3.5-3.5mm longitud 152mm
Screws 3.5-3.5mm length 152mm



P35-035

Tornillos 3.5-3.5mm long 140mm
Screws 3.5-3.5mm length 140mm



P35-027L

Tornillos 3.5-2.7mm longitud 118mm
Screws 3.5-2.7mm length 118mm



P35-027C

Tornillos 3.5-2.7mm longitud 100mm
Screws 3.5-2.7mm length 100mm



P27-020L

Tornillos 2.7-2.0mm longitud 80mm
Screws 2.7-2.0mm length 80mm

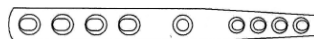

P27-020C

Tornillos 2.7-2.0mm longitud 76mm
Screws 2.7-2.0mm length 76mm

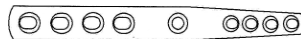

P20-020

Tornillos 2.0-2.0mm longitud 57mm
Screws 2.0-2.0mm length 57mm



P20-015

Tornillos 2.0-1.5mm longitud 53mm
Screws 2.0-1.5mm length 53mm



PLACAS HIBRIDAS PANARTRODESIS CARPAL ESCALONADAS
STEPPED HYBRID PLATES FOR CARPAL PANARTHRODESIS

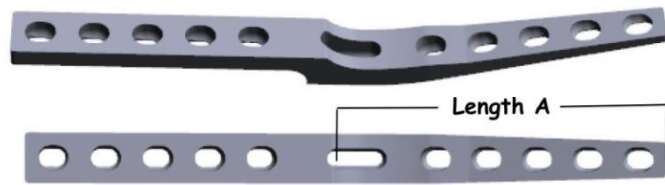

	Longitud Total <i>Total Length</i>	Longitud A <i>Length A</i>
AR35-35L Placa artrodesis carpo escalonada tornillos 3.5-2.7-3.5 <i>Stepped hybrid plate for carpal panarthrodesis 3.5-2.7-3.5 screws</i>	162mm	90mm
AR35-27EL Placa artrodesis carpo escalonada especial larga 3.5-2.7-2.7 <i>Stepped hybrid plate special long 3.5-2.7-2.7 screws</i>	158mm	86.5mm
AR35-27E Placa artrodesis carpo escalonada especial 3.5-2.7-2.7 <i>Stepped hybrid plate special long 3.5-2.7-2.7 screws</i>	148mm	76.5mm
AR35-27LL Placa artrodesis carpo escalonada tornillos 3.5-2.7-2.7 <i>Stepped hybrid plate for carpal panarthrodesis 3.5-2.7-2.7 screws</i>	129mm	76.5mm
AR35-27L Placa artrodesis carpo escalonada tornillos 3.5-2.7-2.7 <i>Stepped hybrid plate for carpal panarthrodesis 3.5-2.7-2.7 screws</i>	120mm	66.5mm
AR35-27CL Placa artrodesis carpo escalonada tornillos 3.5-2.7-2.7 <i>Stepped hybrid plate for carpal panarthrodesis 3.5-2.7-2.7 screws</i>	110mm	57.5mm
AR35-27C Placa artrodesis carpo escalonada tornillos 3.5-2.7-2.7 <i>Stepped hybrid plate for carpal panarthrodesis 3.5-2.7-2.7 screws</i>	101mm	47.5mm
AR27-20L Placa artrodesis carpo escalonada tornillos 2.7-2.0-2.0 <i>Stepped hybrid plate for carpal panarthrodesis 2.7-2.0-2.0 screws</i>	85mm	46mm
AR27-20 Placa artrodesis carpo escalonada tornillos 2.7-2.0-2.0 <i>Stepped hybrid plate for carpal panarthrodesis 2.7-2.0-2.0 screws</i>	76mm	36mm

PLACAS BLOQUEO PANARTRODESIS CARPAL ESCALONADAS
LOCKING STEPPED PLATES



Longitud Total *Total Length* *Length A*

PBAR35-35L

Placa artrodesis carpo escalonada tornillos 3.5-2.7

162mm

90mm

Stepped hybrid plate for carpal panarthrodesis 3.5-2.7 screws

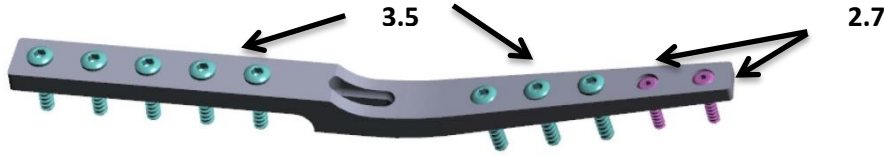

PBAR35-27EL

Placa artrodesis carpo escalonada especial larga 3.5-2.7-2.0

158mm

86.5mm

Stepped hybrid plate special long 3.5-2.7-2.0 screws



PBAR35-27E

Placa artrodesis carpo escalonada especial 3.5-2.7-2.0

148mm

76.5mm

Stepped hybrid plate special long 3.5-2.7-2.0 screws



PBAR35-27LL

Placa artrodesis carpo escalonada tornillos 3.5-2.7-2.0

129mm

76.5mm

Stepped hybrid plate for carpal panarthrodesis 3.5-2.7-2.0 screws



PBAR35-27L

Placa artrodesis carpo escalonada tornillos 3.5-2.7-2.0

120mm

66.5mm

Stepped hybrid plate for carpal panarthrodesis 3.5-2.7-2.0 screws



PBAR35-27CL

Placa artrodesis carpo escalonada tornillos 3.5-2.7-2.0

110mm

57.5mm

Stepped hybrid plate for carpal panarthrodesis 3.5-2.7-2.0 screws



PBAR35-27C

Placa artrodesis carpo escalonada tornillos 3.5-2.7-2.0

101mm

47.5mm

Stepped hybrid plate for carpal panarthrodesis 3.5-2.7-2.0 screws



PBAR27-20L

Placa artrodesis carpo escalonada tornillos 2.7-2.0-1.5

85mm

46mm

Stepped hybrid plate for carpal panarthrodesis 2.7-2.0-1.5 screws

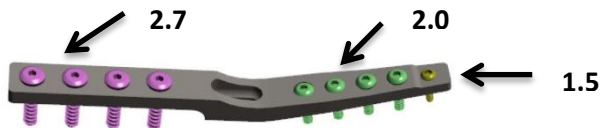

PBAR27-20

Placa artrodesis carpo escalonada tornillos 2.7-2.0-2.0

76mm

36mm

Locking stepped plate for carpal panarthrodesis 2.7-2.0-1.5 screws



PLACAS EN T PARA FACTURAS DISTALES DE RADIO T-PLATES FOR DISTAL RADIAL FRACTURES

T-15 Tornillo 1.5 mm / *Screw 1.5mm*
 Longitud / *length 27mm*
 Ancho cabeza / *Width of T head 7mm*
 Ancho cola / *Width plate shaft 4.0mm*
 Grosor / *Thickness 1.5mm*



T-20C Tornillo 2.0 mm / *Screw 2.0mm*
 Longitud / *length 28mm*
 Ancho cabeza / *Width of T head 9mm*
 Ancho cola / *Width plate shaft 5mm*
 Grosor / *Thickness 1.5mm*

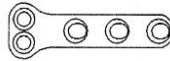

T-20L
 Tornillo 2.0 mm / *Screw 2.0mm*
 Longitud / *length 35mm*
 Ancho cabeza / *Width of T head 9mm*
 Ancho cola / *Width plate shaft 5mm*
 Grosor / *Thickness 1.5mm*



T-27
 Tornillo 2.7 mm / *Screw 2.7mm*
 Longitud / *length 55mm*
 Ancho cabeza / *Width of T head 12.5mm*
 Ancho cola / *Width plate shaft 7mm*
 Grosor / *Thickness 2.5mm*

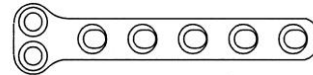

T-27C
 Tornillo 2.7 mm / *Screw 2.7mm*
 Longitud / *length 40mm*
 Ancho cabeza / *Width of T head 16mm*
 Ancho cola / *Width plate shaft 8.0mm*
 Grosor / *Thickness 2.5mm*

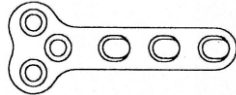

T-35
 Tornillo 3.5 mm / *Screw 3.5mm*
 Longitud / *length 80mm*
 Ancho cabeza / *Width of T head 18mm*
 Ancho cola / *Width plate shaft 11mm*
 Grosor / *Thickness 3.0mm*

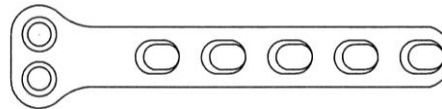

T-35C
 Tornillo 3.5 mm / *Screw 3.5mm*
 Longitud / *length 55mm*
 Ancho cabeza / *Width of T head 22mm*
 Ancho cola / *Width plate shaft 10mm*
 Grosor / *Thickness 3.0mm*

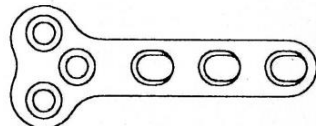

T-35L
 Tornillo 3.5 mm / *Screw 3.5mm*
 Longitud / *length 78mm*
 Ancho cabeza / *Width of T head 24mm*
 Ancho cola / *Width plate shaft 12mm*
 Grosor / *Thickness 3.0mm*

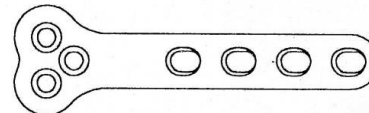

PLACAS DE BLOQUEO EN T LOCKING T PLATES

PBT-15

Placa bloqueada en T para tornillos Ø 1.5 mm

T-locking plate

Longitud/ *length*

26,5mm

Ancho cabeza/ *Width of T head* 7.0mm

Ancho cola/ *Width plate shaft* 4.0mm

Grosor *Thickness* 2.0/1.5mm



PBT-20C Placa en T bloqueada corta

T-Short low contact locking plate

Total length 28 mm

Width of T head 9.0mm

Width plate shaft 5.0mm

Thickness 2.5/2.0mm

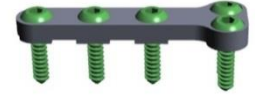

PBT-20L Placa en T bloqueada larga

T-Long low contact locking plate

Total length 35mm

Width of T head 9.0mm

Width plate shaft 5.0mm

Thickness 2.5/2.0mm

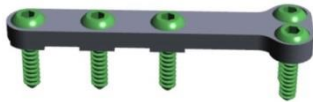

BT-27 Placa bloqueada de bajo contacto en T 2.7mm.

Longitud total 55mm *T- Locking Plate. Total length* 55mm

Ancho cabeza/*Width of T head* 13mm

Ancho /*Width plate* shaft 7.0mm

Grosor/*Thickness* 3.0/2.5mm

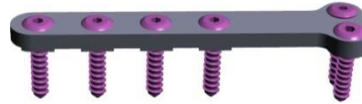

PBT-27C

Placa bloqueada en T corta 2.7

2.7mm low contact T- Locking plate

Longitud / *length* 40mm

Ancho cabeza / *Width of T head* 16mm

Ancho cola / *Width plate shaft* 8.0mm

Grosor / *Thickness* 3.0/2.5mm



PBT-35

Placa bloqueada en T para facturas distales de radio

T-locking plate for distal radial fractures

Longitud / *Length* 80mm

Ancho cabeza / *Width of T head* 18.0mm

Ancho cola/ *Width plate shaft* 11.0mm

Grosor / *Thickness* 4.0mm

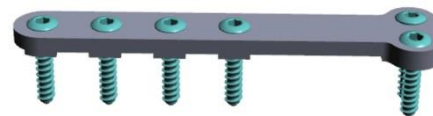

PBT-35C

Placa bloqueada en T corta 3.5

Short locking T plate 3.5mm

Longitud / *Length* 55mm

Ancho cabeza / *Width of T head* 22mm

Ancho cola / *Width plate shaft* 10mm

Grosor / *Thickness* 4.0mm

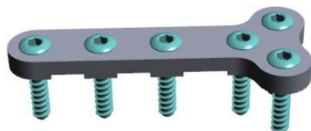

PBT-35L

Placa bloqueada en T larga 3.5

Long locking T plate 3.5mm

Longitud / *Length* 80mm

Ancho cabeza / *Width of T head* 24mm

Ancho cola / *Width plate shaft* 12mm

Grosor / *Thickness* 4.0mm

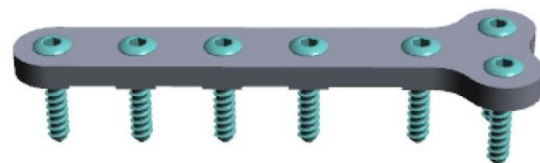

PLACAS ACETABULARES
ACETABULAR PLATES

PLACAS ACETABULARES bloqueo
ACETABULAR LOCKING PLATES

ACT-020

Miniplaca acetabular tornillo 2.0

Mini acetabular plate screw 2.0

Longitud / **Length** 25mm

Grosor / **Thickness** 2.0mm

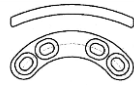

PBACET-020

Placa bloqueada acetabular

Acetabular locking plate

2.0mm screws

ACT-027

Placa acetabular tornillo 2.7

Acetabular plate 2.7 screw

Longitud / **Length** 38mm

Grosor / **Thickness** 2.5mm

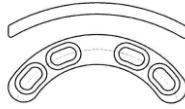

ACT-035

Placa acetabular tornillo 3.5

Acetabular plate 3.5 screw

Longitud / **Length** 44mm

Grosor / **Thickness** 3.0mm

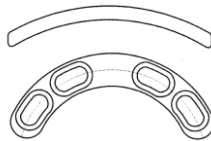

PBACET-027

Placa bloqueada acetabular

Acetabular locking plate

2.7mm screws

AC-20

Miniplaca acetabular tornillo 2.0

Mini acetabular plate screw 2.0

Longitud / **Length** 24.5mm

Grosor / **Thickness** 1.2mm



AC-27C

Placa acetabular corta tornillo 2.7

Short acetabular plate screw 2.7

Longitud / **Length** 33.8mm

Grosor / **Thickness** 1.5mm



PBACET-35

Placa bloqueada acetabular

Acetabular locking plate

3.5mm screws

AC-27L

Placa acetabular larga tornillo 2.7

Long acetabular plate 2.7screw

Longitud / **Length** 36.7mm

Grosor / **Thickness** 2.0mm



AC-35C

Placa acetabular corta tornillo 3.5

Short acetabular plate 3.5mm screw

Longitud / **Length** 43.2mm

Grosor / **Thickness** 2.0mm



AC-35L

Placa acetabular corta tornillo 3.5

Long acetabular plate 3.5 screw

Longitud / **Length** 48.2mm

Grosor / **Thickness** 2.5mm



PLACAS FRACTURAS SUPRACONDILARES DE FEMUR SUPRACONDILAR FEMORAL FRACTURES PLATES

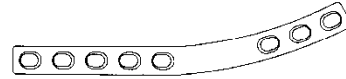
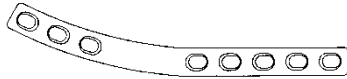

FI-45

PS fémur izdo 4.5 mm long 13 cm
Left femoral plate 4.5 mm length 13 cm

FI-35L

PS larga fémur izdo 3.5 mm long 12 cm
Left long femoral plate 3.5 mm length 12 cm

FI-35C

PS corta fémur izdo 3.5 mm long 11 cm
Left short femoral plate 3.5 mm length 11cm

FI-27L

PS fémur izdo 2.7 mm long 8.0 cm
Left femoral plate 2.7 mm length 8.0 cm

FI-27C

PS fémur izdo 2.7 mm long 6.0 cm
Left femoral plate 2.7 mm length 6.0 cm

FI-20

PS fémur izdo 2.0 mm long 6.0 cm
Left femoral plate 2.0 mm length 6.0 cm

FD-45

PS fémur dcho 4.5 mm long 13 cm
Right femoral plate 4.5 mm length 13 cm

FD-35L

PS larga fémur dcho 3.5 mm long 12 cm
Right long femoral plate 3.5mm length 12 cm

FD-35C

PS corta fémur dcho 3.5 mm long 11 cm
Right short femoral plate 3.5 mm length 11 cm

FD-27L

PS fémur dcho 2.7 mm long 8.0 cm
Right femoral plate 2.7 mm length 8.0 cm

FD-27C

PS fémur dcho 2.7 mm long 6 cm
Right femoral plate 2.7 mm length 6.0 cm

FD-20

PS fémur dcho 2.0 mm long 6.0 cm
Right femoral plate 2.0 mm length 6.0 cm

PLACAS BLOQUEO FEMORALES

LOCKING FEMORAL PLATES



3.5



PBFD- 35L *Right S long femoral locking plate* **PBFi-35L** *Left S long femoral locking plate*
PBFD-35C *Right short femoral locking plate* **PBFi- 35C** *Left S short femoral locking plate*



2.7



PBFD-27L *Right long femoral locking plate* **PBFi-27L** *Left long femoral locking plate*
PBFD-27C *Right short femoral locking plate* **PBFi-27C** *Left femoral locking plate*



2.0



PBFD-20 *Right femoral plate*

PBFi-20 *Left S femoral plate*

PLACAS FRACTURAS SUPRACONDILARES FEMORALES
SUPRACONDILAR FEMORAL FRACTURES PLATES

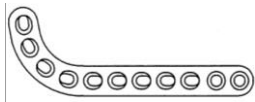

FED-20 Right FEI-20 Left
 Long/*Length*: 51mm Ancho/*width*: 6.0mm Grosor/*thickness*: 1.5mm

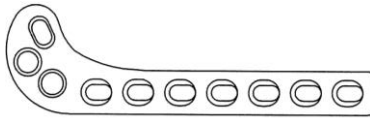

FED-27 Right FEI-27 Left
 Long/*Length*: Ancho/*width*: 8.0mm Grosor/*thickness*: 2.5mm



FED-35E Right FEI-35E Left
 Long/*Length*: 10.5mm Ancho/*width*: 10mm Grosor/*thickness*: 4.0mm

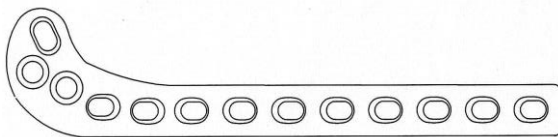

FED-35A Right FEI-35A Left
 Long/*Length*: 13.5mm Ancho/*width*: 12.5mm
 Grosor/*thickness*: 4.0mm

PLACAS BLOQUEADAS SUPRACONDILARES FEMUR
SUPRACONDILAR FEMORAL LOCKING PLATES



PBFED-35A Right PBFEI-35A Left
 Longitud/*Length*: 137mm Ancho/*Width*: 12.5mm
 Grosor/*Thickness*: 4.0mm



PBFED-35E Right PBFEI-35E Left
 Longitud/*Length*: 105mm Ancho/*Width*: 10mm
 Grosor/*Thickness*: 4.0/3.5mm



2.7

PBFED-27 Right PBFEI-27 Left
 Longitud/*Length*: mm Ancho/*Width*:
 Grosor/*Thickness*: mm



2.0

PBFED-20 Right PBFEI-20 Left
 Long/*Length*: 51mm Ancho/*width*: 6.0mm
 Grosor/*thickness*: 2.5mm

CLAVOS CERROJADOS *INTERLOCKING NAILS*

2500-004

Guía externa clavos de 4.0 y 5.0 mm

4.0 and 5.0 diameter ILN jig

2500-005

Guía externa clavos de 6.0 a 10.0 mm

6.0 to 10 diameter ILN jig



Guías de broca *Drill guides*

2500-015 1.5 mm **2500-032** 3.2 mm

2500-020 2.0 mm **2500-035** 3.5mm

2500-027 2.7mm **2500-045** 4.5mm

2500-025 2.5 mm



Steinmann punta trocar / tres planos long 250mm

Steinmann trocar point / three planes length 250

diámetro / **diameter**

0440-250 4.0 mm

0450-250 5.0 mm

0460-250 6.0 mm

0470-250 7.0 mm

0480-250 8.0 mm

0490-250 9.0 mm

0410-250 10 mm



Varilla fijadora del centrador

Centrator fixateur nail

VFC-4-5 4-5mm

VFC-6-10 6-10mm



Centrador clavos cerrojados

ILN centrator

CCC-4-5 4/5mm

CCC-6-7 6/7mm

CCC-8-10 8/9/10mm



Arandela plana clavos cerrojados *Flat wash*

A-CC-4-5 4/5mm

A-CC-6-10 6/10mm



Arandela grafilada clavos cerrojados *Graphylated wash*

AG-CC-4-5 4/5mm

AG-CC-6-10 6/10mm



**CLAVOS CERROJADOS
ORIFICIOS CONTINUOS
INTERLOCKING NAILS
MULTIPLE HOLES**

**CLAVOS CERROJADOS
ORIFICIOS DISCONTINUOS
INTERLOCKING NAILS
FOUR-HOLES**

2504-020 ILN 4.0 mm
2.0 mm screws

2505-027 ILN 5.0 mm
2.7 mm screws

2506-027 ILN 6.0 mm
2.7 mm screws

2507-035 ILN 7.0 mm
3.5 mm screws

2508-035 ILN 8.0 mm
3.5 mm screws

2509-035 ILN 9.0 mm
3.5 mm screws

2510-045 ILN 10 mm
4.5 mm screws



2514-110 ILN 110mm length distal holes 4-5 screws 2.0mm

2514-125 ILN 125mm length distal holes 5-6 screws 2.0mm

2514-140 ILN 140mm length distal holes 6-7 screws 2.0mm

2515-125 ILN 125mm length distal holes 5-6 screws 2.7mm

2515-140 ILN 140mm length distal holes 6-7 screws 2.7mm

2515-155 ILN 155mm length distal holes 7-8 screws 2.7mm

2516-140 ILN 140mm length distal holes 6-7 screws 2.7mm

2516-155 ILN 155mm length distal holes 7-8 screws 2.7mm

2516-170 ILN 170mm length distal holes 8-9 screws 2.7mm

2516-185 ILN 185mm length distal holes 9-10 screws 2.7mm

2517-155 ILN 155mm length distal holes 7-8 screws 3.5mm

2517-170 ILN 170mm length distal holes 8-9 screws 3.5mm

2517-185 ILN 185mm length distal holes 9-10 screws 3.5mm

2517-200 ILN 200mm length distal holes 10-11 screws 3.5mm

2518-170 ILN 170mm length distal holes 8-9 screws 3.5mm

2518-185 ILN 185mm length distal holes 9-10 screws 3.5mm

2518-200 ILN 200mm length distal holes 10-11 screws 3.5mm

2518-215 ILN 215mm length distal holes 11-12 screws 3.5mm

2519-170 ILN 170mm length distal holes 8-9 screws 4.5mm

2519-185 ILN 185mm length distal holes 9-10 screws 4.5mm

2519-200 ILN 200mm length distal holes 10-11 screws 4.5mm

2519-215 ILN 215mm length distal holes 11-12 screws 4.5mm

2519-230 ILN 230mm length distal holes 12-13 screws 4.5mm



0463-007

Medidor tornillos especial clavos cerrojados

Special ILN depth gauge until 50 mm



CAJAS Y BANDEJAS PARA INSTRUMENTAL Y TORNILLOS *CASES AND TRAYS FOR IMPLANTS AND SCREWS*

CP-BT

Caja perforada y bandejas
tornillos BT-1 y BT-2
*Perforated case and trays
for screw BT-1 and BT-2*



BT-1 Bandeja tornillos 1.5, 2.0, 2.4, 2.7, y 4.0 de rosca parcial

Screw tray for 1.5, 2.0, 2.4, 2.7, and 4.0 (partial thread) mm screws

BT-2 Bandeja tornillos 3.5, 4.0 (rosca completa), 4.5 y 6.5

Screw tray for 3.5, 4.0 (full thread), 4.5 and 6.5 mm screw

BT-3T

Bandeja con tapa para tornillos 1.5, 2.0, 2.4, 2.7 y 3.5

Screw tray with tap for 1.5, 2.0, 2.4, 2.7 and 3.5mm screws



C-FE

Conjunto caja fijación externa compuesto de una caja perforada y 3 bandejas
Case for external fixateur: perforated case and 3 trays

1ª bandeja: agujas Kirschner y barras conectoras
1st tray: Kirschner wires and connecting bars

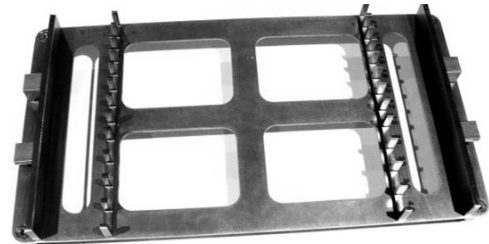

2ª bandeja: rótulas
2nd tray: Clamps

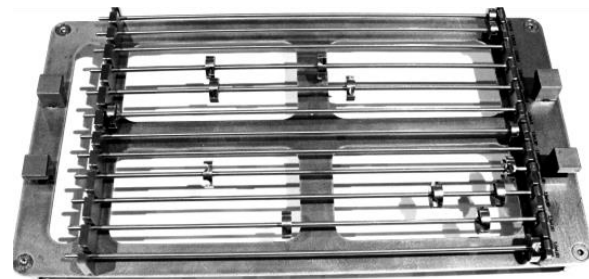

3ª bandeja: agujas rosca positiva
3rd tray: positive profile wires

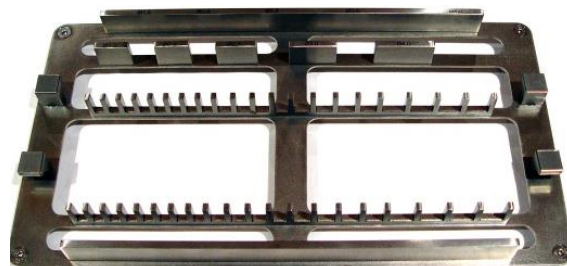

FIJACION EXTERNA EXTERNAL FIXATION

Rótulas simples *Single connecting bars clamps*

2512-015 Rótulas 1.2 x 1.5mm
2515-020 Rótulas 1.5 x 2.0mm
2520-030 Rótulas 2.0 x 3.0mm
2520-040 Rótulas 2.0 x 4.0mm
2525-040 Rótulas 2.5 x 4.0mm
2530-040 Rótulas 3.0 x 4.0mm



Rótulas doble barra conectora *Double connecting bars clamps*

2512-015D Rótulas 1.2 x 1.5mm
2515-020D Rótulas 1.5 x 2.0mm
2520-030D Rótulas 2.0 x 3.0mm
2520-040D Rótulas 2.0 x 4.0mm
2525-040D Rótulas 2,5 x 4.0mm
2530-040D Rótulas 3.0 x 4.0mm



Barras conectoras longitud 280 mm *Connecting bars length 280mm*

2500-228 Barra conectora Ø 2.0 mm
2500-328 Barra conectora Ø 3.0 mm
2500-428 Barra conectora Ø 4.0 mm

2525-020 Rótulas estriadas para agujas de 1.5-2.0
2525-025 Rótulas estriadas para agujas de 2.5-3.0-4.0
Striated clamps for wires 1.5-2.0-2.5-3.0 and 4.0



CI15-020 Cilindro para agujas de 1.5-2.0
CI25-030 Cilindro para agujas de 2.5-3.0
CI40-040 Cilindro para agujas de 4.0

Cylinder for wires 1.5-2.0, 2.5-3.0 and 4.0



BR6-DI Barra roscada 6.0 roca a derecha e izquierda
Connecting bars 6.0 mm half thread to the right and half to the left



EL-C
 Elongador de hueso cuadrado
Squared bone lengthening



AH-0 Anillo hexagonal
Hexagonal ring



AGUJAS ROSCA POSITIVA PUNTA Y CENTRAL POSITIVE PROFILE END LENGTH AND CENTRAL THREAD WIRES



RP12-008

Aguja de Ø 1.2 mm rosca punta 8 mm
1.2 mm wire end length thread 8 mm

RP15-008

Aguja de Ø 1.5 mm rosca punta 8 mm
1.5 mm wire end length thread 8 mm

RP15-015

Aguja de Ø 1.5 mm rosca punta 15 m
1.5 mm wire end length thread 15 m

RP20-015

Aguja de Ø 2.0 mm rosca punta 15 m
2.0 mm wire end length thread 15 m

RP20-020

Aguja de Ø 2.0 mm rosca punta 20 m
2.0 mm wire end length thread 20 m

RP25-015

Aguja de Ø 2.5 mm rosca punta 15 m
2.5 mm wire end length thread 15 m

RP25-025

Aguja de Ø 2.5 mm rosca punta 25 m
2.5 mm wire end length thread 25 m

RP30-020

Aguja de Ø 3.0 mm rosca punta 20 m
3.0 mm wire end length thread 20 m

RP30-030

Aguja de Ø 3.0 mm rosca punta 30 m
3.0 mm wire end length thread 30 m

RP40-020

Aguja de Ø 4.0 mm rosca punta 20 m
4.0 mm wire end length thread 20 m

RP40-030

Aguja de Ø 4.0 mm rosca punta 30 m
4.0 mm wire end length thread 30 m



RC12-008

Aguja de Ø 1.2 mm rosca central 8 mm
1.2mm wire central length thread 8 mm

RC15-008

Aguja de Ø 1.5 mm rosca central 8 mm
1.5mm wire central length thread 8 mm

RC15-015

Aguja de Ø 1.5 mm rosca central 15 mm
1.5mm wire central length thread 15 mm

RC20-010

Aguja de Ø 2.0 mm rosca central 10 mm
2.0mm wire central length thread 10 mm

RC20-020

Aguja de Ø 2.0 mm rosca central 20 mm
20mm wire central length thread 20 mm

RC25-020

Aguja de Ø 2.5 mm rosca central 20 mm
2.5mm wire central length thread 20 mm

RC25-030

Aguja de Ø 2.5 mm rosca central 30 mm
2.5mm wire central length thread 30 mm

RC30-020

Aguja de Ø 3.0 mm rosca central 20 mm
30mm wire central length thread 20 mm

RC30-030

Aguja de Ø 3.0 mm rosca central 30 mm
30mm wire central length thread 30 mm

RC40-020

Aguja de Ø 4.0 mm rosca central 20 mm
4.0mm wire central length thread 20 mm

RC40-030

Aguja de Ø 4.0 mm rosca central 30 mm
4.0mm wire central length thread 30 mm

**BROCAS, AGUJAS DE KIRSCHNER, CLAVOS DE STEINMANN,
CERCLAJES Y KISHIGAMI DRILL BITS, KIRSCHNER WIRES,
STEINMANN NAILS AND CERCLAGES WIRES AND KISHIGAMI**

Brocas lisas *Drill bits*

Referencia Diámetro Longitud
Reference Diameter Length

B-11	Ø 1.1mm	60mm
B-15	Ø 1.5mm	90mm
B-20	Ø 2.0mm	100mm
B-25	Ø 2.5mm	130mm
B-27	Ø 2.7mm	130mm
B-32	Ø 3.2mm	130mm
B-35	Ø 3.5mm	130mm
B-45	Ø 4.5mm	130mm



Brocas anclaje rápido *Drills with quick fit*

Referencia Diámetro Longitud
Reference Diameter Length

BA-11	Ø 1.1mm	60mm
BA-15	Ø 1.5mm	90mm
BA-20	Ø 2.0mm	100mm
BA-25	Ø 2.5mm	130mm
BA-27	Ø 2.7mm	130mm
BA-32	Ø 3.2mm	130mm
BA-35	Ø 3.5mm	130mm
BA-45	Ø 4.5mm	130mm



Agujas Kirschner dos puntas trocar
Kirschner wires two trocar points

Referencia Diámetro Longitud
Reference Diameter Length

K-0.6	Ø 0.6	70mm
K-0.8	Ø 0.8	285mm
K-10	Ø1.0	285mm
K-12	Ø1.2	285mm
K-15	Ø1.5	285mm
K-18	Ø1.8	285mm
K-20	Ø2.0	285mm
K-22	Ø2.2	285mm
K-25	Ø2.5	285mm
K-30	Ø3.0	285mm

Steinmann punta trocar-tres planos 250 mm longitud
Steinmann trocar point-three planes 250mm length

Referencia Diámetro Longitud
Reference Diameter Length

0440-250	Ø 4.0mm	250mm
0450-250	Ø 5.0mm	250mm
0460-250	Ø 6.0mm	250mm
0470-250	Ø 7.0mm	250mm
0480-250	Ø 8.0mm	250mm
0490-250	Ø 9.0mm	250mm
0410-250	Ø 10mm	250mm



Rollos cerclajes de 10 metros *Rolls of soft wire 10 meters*

0407-006 diámetro/*diameter* 0.6 mm **0407-010** diámetro/*diameter* 1.0 mm
0407-008 diámetro/*diameter* 0.8 mm **0407-012** diámetro/*diameter* 1.2 mm
0407-009 diámetro/*diameter* 0.9 mm **0407-015** diámetro/*diameter* 1.5 mm



Retractores de Kishigamy 3 asas
Kishigamy retractor 3 hooks

KS-3H *Small Kishigami*
KM-3H *Medium Kishigami*
KL-3H *Large Kishigami*



Retractores de Kishigamy 4 asas
Kishigamy retractor 4 hooks

KS-4H *Small Kishigami*
KM-4H *Medium Kishigami*
KL-4H *Large Kishigami*



INSTRUMENTAL PARA EL ATORNILLADO

INSTRUMENTS FOR TAPPING AND SCREWING

MAR-R

Mango anclaje rápido empuñadura recta
Strait handle with quick fit



AR-M

Pieza de anclaje rápido para motores
Quick fit piece for drill bite motors



MAR-T

Mango anclaje rápido empuñadura en T
T handle with quick fit



Pasamachos anclaje rápido
Tap with quick fit



- PM-15** Tornillos/*Screws* 1.5mm
- PM-20** Tornillos/*Screws* 2.0mm
- PM-27** Tornillos/*Screws* 2.7mm
- PM-34** Tornillos/*Screws* 3.5mm
(paso de rosca / *pitch of thread* 1.75)
- PM-35** Tornillos/*Screws* 3.5mm
(paso de rosca / *pitch of thread* 1.25)
- PM-40** Tornillos/*Screws* 4.0mm
- PM-45** Tornillos/*Screws* 4.5mm

Pasamachos con mango en T
Tap with T-handle

- PM-15T** Tornillos/*Screws* 1.5mm
- PM-20T** Tornillos/*Screws* 2.0mm
- PM-27T** Tornillos/*Screws* 2.7mm
- PM-34T** Tornillos/*Screws* 3.5mm
(paso de rosca / *pitch of thread* 1.75)
- PM-35T** Tornillos/*Screws* 3.5mm
(paso de rosca / *pitch of thread* 1.25)
- PM-40T** Tornillos/*Screws* 4.0mm
- PM-45T** Tornillos/*Screws* 4.5mm
- PM-65T** Tornillos/*Screws* 6.5mm



Avellanador anclaje rápido
Countersink with quick fit

- AV-11** punta/*tip* 1.1mm
- AV-15** punta/*tip* 1.5mm
- AV-20** punta/*tip* 2.0mm
- AV-25** punta/*tip* 2.5mm
- AV-32** punta/*tip* 3.2mm



Avellanador mango en T
Countersink T handle

- AV-11T** punta/*tip* 1.1mm
- AV-15T** punta/*tip* 1.5mm
- AV-20T** punta/*tip* 2.0mm
- AV-25T** punta/*tip* 2.5mm
- AV-32T** punta/*tip* 3.2mm

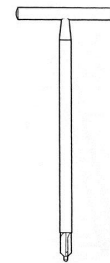

Atornilladores anclaje rápido con/sin pinza
Screwdrivers quick fit with/without forceps



- AT-15** Screws 1.5-2.0 *without forceps*
- AT-15P** *with forceps*
- AT-27** Screws 2.7-3.5- *without forceps*
- AT-27P** *with forceps*
- AT-45** Screws 4.5-6.5 *without forceps*

Atornillador con mango con/sin pinza
Screwdriver with handle with/without forceps



- AT-15M** Screws 1.5-2.0 *without forceps*
- AT-15MP** *with forceps*
- AT-27M** Screws 2.7-3.5- *without forceps*
- AT-27MP** *with forceps*
- AT-45M** Screws 4.5-6.5 *without forceps*
- AT-45MP** *with forceps*

MOTORES PARA TALADROS Y SIERRA OSCILANTE
MOTORS FOR DRILLS AND OSCILLATING SAW

SO-000
 Sierra oscilante
Oscillating saw

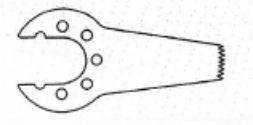

S40-023

Hojas sierra para la SO-000
Saw blades for model SO-000

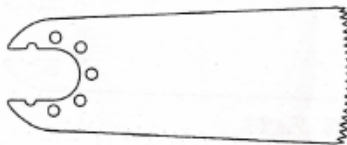

S40-010

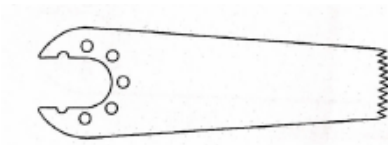

S40-15

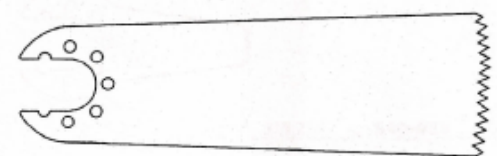

S40-17

Hojas circulares para la sierra SO-000

HC-18N Circular blades radius 18mm
HC-24N Circular blades radius 24mm
HC-30N Circular blades radius 30mm



Otras hojas para sierra oscilante
Other blades for oscillating saws



S32-125 Hoja pequeña (small) **S32-123 Hoja mediana (medium)** **S32-124 Hoja ancha (large)**

Drem 1 Motor fortiflex Fortiflex Dremel motor



Drem 2 Pieza de acople de todos los accesorios: portabrocas, sierra oscilante sagital, sierra oscilante circular (TPLO) y fresadora
Piece for attachment drill bite, oscilating saw, circular oscillating saw (TPLO), bone milling





Drem-2 Sierra oscilante sagital *Sagital* **Drem 3** Sierra circular *Circular (TPLO) saw*
oscillating saw



Drem-4
 Portabrocas
Drill bite



Drem 5
 Portaguijas
 Kirschner



Drem-6 Fresadora *Bone milling*



Fresas de 1.0, 2.0, 3.0, 4.0, 5.0 y 6.0mm
 F-1mm
 F-2mm
 F-3mm
 F-4mm
 F-5mm
 F-6mm



Mini fresadora **MINI-Fres**



LAP-REC Lápis recto *Straight pen*



LAP-ACD Lápis acodado

TAL-000



Taladro
Drill bite

Port-000
Portabrocas



TAL-INS

Taladro Insorvet



Giro a derecha e izda. Movimiento oscilante con broca

Sin baterías, alimentado por fuente externa (cable)

Peso muy reducido

Se le acoplan las siguientes piezas:

Sierra oscilante sagital, sierra oscilante circular, portabrocas, porta agujas

Hojas de sierra DREM-03

SCH-HC12 Hoja circular radio 12mm

SCH-HC14 Hoja circular radio 14mm

SCH-HC18 Hoja circular radio 18mm

SCH-HC22 Hoja circular radio 22mm

SCH-HC26 Hoja circular radio 26mm

SCH-HC30 Hoja circular radio 30mm



PROTESIS DE CADERA NO CEMENTADA CEMENTLESS HIP PROSTHESIS

Contactar con Insorvet para viabilidad del producto *Contact with Insorvet*

Excelente adaptación al hueso por su curvatura y anteversión

V-6D Vástago 6 dcha

V-6I Vástago 6 izda

V-7D Vástago 7 dcha

V-7I Vástago 7 izda

V-8D Vástago 8 dcha

V-8I Vástago 8 izda

V9D Vástago 9 dcha

V9I Vástago 9 izda

V10D Vástago 10 dcha

V10I Vástago 10 izda



TICA-22.5 Cótulo titanio 22.5 mm

Acetabular cap titanium shell 22.5 mm

TICA-24.5 Cótulo titanio 24.5 mm

Acetabular cap titanium shell 24.5 mm

TICA-26.5 Cótulo titanio 26.5 mm

Acetabular cap titanium shell 26.5 mm

TICA-28.5 Cótulo titanio 28.5 mm

Acetabular cap titanium shell 28.5 mm

TICA-30.5 Cótulo titanio 30.5 mm

Acetabular cap titanium shell 30.5 mm



GC-D

Guía dcha



CAPE-22.5 UHMWPE 22.5

CAPE-24.5 UHMWPE 24.5

CAPE-26.5 UHMWPE 26.5

CAPE-28.5 UHMWPE 28.5

CAPE-30.5 UHMWPE 30.5

Cabeza femoral Cromo-cobalto

Femoral head CrCo

CF-14-0

CF-14-1

CF-14-2

CF-14-3



INSTRUMENTAL INSTRUMENTS

Smille meniscotom

- 7750-000 Meniscotomo Smille recto
7750-001 Meniscotomo Smille curvo
7750-002 Meniscotomo Smille curvo



Bircher meniscotom

- 7750-031 Meniscotomo Bircher recto 20 cm
7750-035 Meniscotomo Bircher curvo 20 cm
7750-036 Meniscotomo Bircher curvo 20 cm



Smith meniscotomo

- 7750-021 Meniscotomo Smith ancho 13 mm
7750-022 Meniscotomo Smith ancho 16 mm
7750-023 Meniscotomo Smith ancho 19 mm



Bone chisel

- 2805-004 Osteotomo superficie corte 4.0 mm long 14 cm
2805-006 Osteotomo superficie corte 6.0 mm long 14 cm
2805-008 Osteotomo superficie corte 8.0 mm long 14 cm
2805-010 Osteotomo superficie corte 10.0 mm long 14 cm
2805-012 Osteotomo superficie corte 12.0 mm long 14 cm
2821-018 Osteotomo superficie corte 18.0 mm long 16 cm



Bone chisel

- 2804-004 Osteotomo unibiselado corte 4.0 mm long 14 cm
2804-006 Osteotomo corte 6.0 mm long 14 cm
2804-008 Osteotomo corte 8.0 mm long 14 cm
2804-010 Osteotomo corte 10.0 mm long 14 cm
2804-012 Osteotomo corte 12.0 mm long 14 cm
2820-018 Osteotomo corte 18.0 mm long 16 cm



Double Volkman spoon

- 2951-025
Cucharilla Volkman doble ancho boca 2x3
2951-026
Cucharilla Volkman doble ancho boca 4x5
2951-027
Cucharilla Volkman doble ancho boca 6x7



SP-771

Mango hojas osteotomo
Chisel Handle



SP-770 Hoja/blade width 5.0mm
SP-771 Hoja/blade width 10mm
SP-772 Hoja/blade width 16mm
SP-773 Hoja/blade width 25mm



SP-97

Llave/wrench

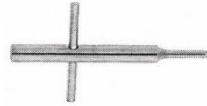

Ruskin rongeurs

length

3104-002 Gubia recta diámetro boca 2.0 long 15 cm
Straight Ruskin mouth 2.0mm

3104-003 Gubia recta diámetro boca 3.0 long 15 cm
Straight Ruskin mouth 3.0mm

3105-002 Gubia curva diámetro boca 2.0 long 15 cm
Curved Ruskin mouth 2.0mm

3105-003 Gubia curva diámetro boca 3.0 long 15 cm
Curved Ruskin mouth 3.0mm



Kern bone holding forceps

0380-015 Pinzas Kern 15 mm

0380-017 Pinzas Kern 17 mm

0380-021 Pinzas Kern 21 mm



HOH-06 Hohmann 6.0 mm ancho
Hohmann retractor width 6.0 mm

HOH-08 Hohmann 8.0 mm ancho
Hohmann retractor width 8.0 mm



HOH-18 Hohmann perros medianos y grandes 18 mm ancho
Hohmann retractor width 18 mm

Pinza sujeción hueso *Reduction forceps with serrated jaw with speed lock*

0623-005 Longitud/*Length* 220 mm

0623-006 Longitud/*Length* 160 mm



4040-517 Distractor rodilla 17 cm
Knee distractor

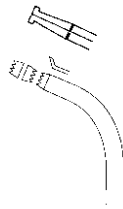

716-22 Pinzas Verbrugge con sujeción para hueso en ambos lados.

Longitud 150 mm



716-23 Pinzas Verbrugge con sujeción para hueso en ambos lados.

Longitud 190 mm



716-24 Pinzas Verbrugge con sujeción para hueso en ambos lados.

Longitud 260 mm



0623-009

Pinza reducción pequeña 140 mm con cremallera
Reduction forceps with serrated jaw 140 mm, ratchet

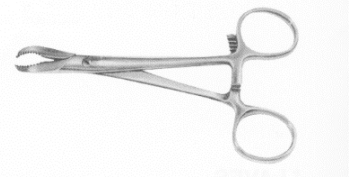

Pinza reducción con puntas curvas y cierre axial
Reduction forceps with curved points and speed lock

Longitud/ *length*

PRP-013 130 mm

PRP-016 160 mm

PRP-020 200 mm



1651-090

Pinzas Heiss para la disección del ductus arterioso y otras aplicaciones

Heiss vascular clamp used for ductus arteriosus dissection and other applications



5010-016

Pinzas de sujeción atraumáticas de Babcock
Babcock atraumatic tissue holding forceps



27-3850

Pinzas Ruskin Corta Hueso. 18cm
Ruskin bone cutting forceps. 18cm



22-2291

Alicates Liston Corta Hueso 12,5cm
Liston bone cutting forceps. 12,5cm



22-2257

Pinzas para tejidos Allis 16cm
Allis tissue seizing forceps 16cm

22-2258

Pinzas para tejidos Allis 19cm
Allis tissue seizing forceps 19cm



14-772

Pinzas Backhaus. 11cm
Backhaus towel forceps. 11cm



15-162

Pinzas hemostáticas Mosquito recta. 12,5cm
Mosquito straight hemostatic forceps. 12,5cm



439

Pinzas hemostáticas Mosquito curva. 12,5cm
Mosquito curved hemostatic forceps. 12,5cm



17-137
 Pinzas hemostáticas Kocher dentadas curva
Kocher hemostatic curved forceps



17-136
 Pinzas hemostáticas Kocher dentadas recta
Kocher hemostatic straight forceps



Gelpi retractor

	Longitud/ <i>Length</i>
GI-090 Gelpi	9 cm
GI-140 Gelpi	14 cm
GI-190 Gelpi	19 cm
GI-170 Gelpi	17 cm
brazos angulación 90°	
<i>90° arms angulation</i>	



Weitlaner retractor

	Longitud/ <i>Length</i>
WET-001	
Separador Weitlaner con punta roma	11 cm
WET-002	
Separador Weitlaner con punta roma	13 cm
WET-003	
Separador Weitlaner con punta roma	16 cm
WET-004	
Separador Weitlaner con punta roma	19 cm

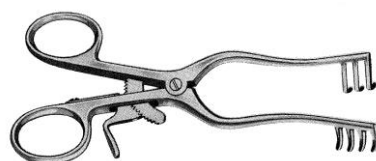

Laminectomy cutting forceps

- 5706-003**
Pinzas laminectomía rectas ancho boca 3.0 mm long 15 cm
- 5706-005**
Pinzas laminectomía rectas ancho boca 5.0 mm long 15 cm
- 5706-023**
Pinzas laminectomía angulo 40° ancho boca 3.0 mm long 15 cm
- 5706-025**
Pinzas laminectomía angulo 40° ancho boca 5.0 mm long 15 cm

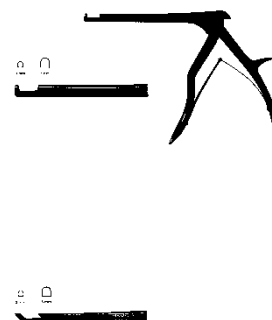

CZ-30 Cizalla corte clavos 30 cm longitud
CZ-40 Cizalla corte clavos 40 cm longitud

Corta 4.0mm
Rod cutter maximum cut 4.0 mm diameter



Wire-cutter
7645-045 Alicates de corte 23 cm



Wire-cutter
7645-046 Alicates de corte 15 cm

7645-050 Alicates de corte 14 cm
Small wire-cutter



SP- 1616
Alicates de corte 24cm: corte hasta 3.0mm
Wire-cutter: cut until 3.0mm wires



AL-TG
Alicates corte puntas de tungsteno 23 cm
Wire-cutter tungsten point 23 cm



AL-TGI
Alicates de corte puntas de tungsteno
corte inclinado 23 cm
*Wire-cutter tungsten point 23 cm
inclined cut*



AL-TGIS
Alicates de corte pequeño puntas de
tungsteno
corte inclinado 17 cm
*Wire-cutter tungsten point small 17 cm
inclined cut*



HER-000 Alicates Hércules hoja fija
HER-001 Alicates Hércules hojas intercambiables
Wire-cutter tungsten point



0607-091 Alicates universal 180mm
Flat-nosed parallel pliers



0607-088 Alicates de bloqueo longitudinal 18 cm
Locking pliers 18 cm

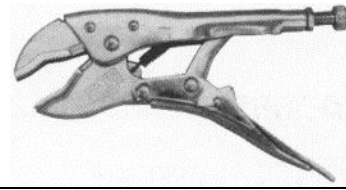

0607-089 Alicates bloqueo 23 cm
Locking pliers 23 cm

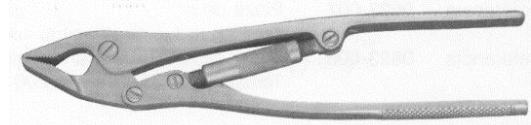

3901-010 Alicates doblado placas pequeñas
Universal bending pliers



22-2253-11
Porta-agujas Guillies curvo 11cm
Guillies needle holder curved 11cm

22-2253-16
Porta-agujas Guillies curvo 16cm
Guillies needle holder curved 16cm



22-2227
Porta-agujas Webster 13cm
Webster needle holder 13cm



22-2223
Porta-agujas Mathieu 17cm
Mathieu needle holder 17cm



31-286
Porta-agujas Olsen-Hegar 14cm
Olsen-Hegar needle holder. 14cm



22-2018
Pinzas Wangensteen no dentadas 15cm
Forceps Wangensteen 15cm



22-2014
Pinzas Chir. Pinzette no dentadas 16cm
Forceps Chir Pinzette 16cm



22-2004
Pinzas de disección no dentadas 18cm
Dressing forceps 18cm



0463-097 Pinza sujeción tornillos
Screw forceps



22-2273
Tijeras Mayo recta 17cm
Mayo straight scissors 17cm



22-2271
Tijeras Mayo curva 17cm
Mayo curved scissors 17cm

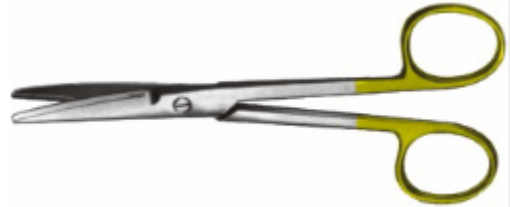

22-2276
Tijeras Mayo-Stille curva 15cm con carburo de tungsteno
Mayo-Stille curved scissors with tungsten carbide edges 15cm



22-2274
Tijeras Mayo-Stille rectas 15cm con carburo de tungsteno
Mayo-Stille straight scissors with tungsten carbide edges 15cm



22-2269
Tijeras Lister de carburo de tungsteno. 18cm
Lister scissors with tungsten carbide edges. 18cm



22-2281
Tijeras curvas Metzbaum de carburo de tungsteno 18cm
Metzbaum curved scissors with tungsten carbide edges 18cm



22-2285
Tijeras rectas Metzbaum de carburo de tungsteno 18cm
Metzbaum straight scissors with tungsten carbide edges 18cm



22-2289-01
Tijeras Irisschere de carburo de tungsteno 11,5cm
Irisschere scissors with tungsten carbide edges 11,5cm.



11-141
Tijeras saca puntos Spencer 13cm
11-137
Tijeras saca puntos Buck 14,5cm



27-3654
Raspa para huesos Putti 27cm
Putti bone rasp 27 cm



27-3653
Lima para huesos Putti 30cm
Putti bone file 30cm



3580-018 C
Clamp de Lowman 18 cm
Lowman bone holding forceps 18 cm

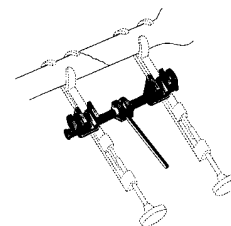

3582-090
Coaptador clamps Lowman
Holding clamp Lowman forceps



Finochieto rib retractor

5422-051
Separador Finochieto valvas 18mm profundidad máxima de 90 mm

5422-065
Separador Finochieto valvas 31mm profundidad máxima de 100 mm



separación

separación

2455-002
Separador de Gosset
Gosset retractor



5763-005
Trefina de Michele para biopsia de hueso bocado de 5.0 mm
Bone biopsy Michele trephine mouth 5.0 and 8.0mm

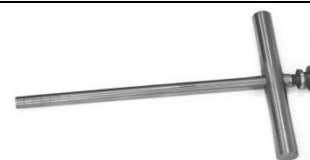

5763-008
Trefina de Michele para biopsia de hueso bocado de 8.0 mm

5764-030 Sierra de Gigli de 30 cm de longitud *Length 30 cm*

5764-040 Sierra de Gigli de 40 cm de longitud
Length 40 cm

5764-002 Mangos para la sierra de Gigli

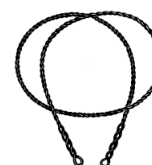

Hammer **grams**
0715-005 Martillo 350 grs
0715-006 Martillo 500 grs
0715-007 Martillo 800 grs



1625-000 Porta grapas de H. Ros
H. Ros staples driver

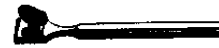

1630-000 Impactador de grapas
H. Ros impactor driver



1635-000 Extractor de grapas
H. Ros staples elevator



0445-075
Portabrocas inoxidable hasta 6.0mm
diámetro mango aluminio
Stainless steel drill bit until 6.0mm
aluminium handle



724-00 Pasahilo pequeño ojal en ambas puntas
Small Cable passer



724-02 Pasahilo grande ojal en ambas puntas
Big Cable passer

Sirven también para realizar el “over the top”
For “over the top” technique

GF-000 Grifas
Bending iron



SP-237 Grifas **Bending iron**

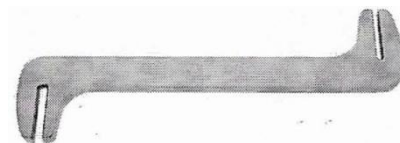

Med-000 Medidor de agujas, brocas y tornillos
Gauge for drill bits, Kirchner wires and screws



0483-030 Prensa doblar placas
Plate-bending press

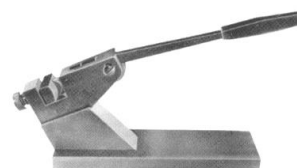

0607-020 Tensor cerclajes de una clavija sin mango
Wire tightener without handle and one peg



Epyphysis staples

- 1670-135** Grapas de epifísis ancho 13,50 altura 22.00
- 1670-213** Grapas de epifísis ancho 21,30 altura 23.50
- 1670-264** Grapas de epifísis ancho 26,40 altura 24.75
- 1670-310** Grapas de epifísis ancho 31,00 altura 24.00

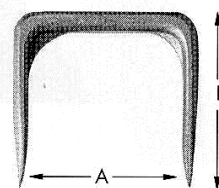

Grapa dentada para técnica “over the top”

Serrated staple

- 1640-006** Ancho/*width* 6.0 mm largo/*length* 26 mm
- 1640-008** Ancho/*width* 8.0 mm largo/*length* 26 mm
- 1640-011** Ancho/*width* 11 mm largo/*length* 26 mm
- 1640-014** Ancho/*width* 14 mm largo/*length* 26 mm

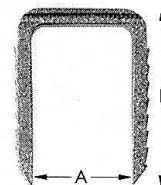

Grapas acero 2.0 mm diámetro

Stainless steel staples 2.0 mm diameter

	longitud/ <i>length</i>	ancho/ <i>width</i>
1640-001	13mm	11mm
1640-002	16mm	18mm
1640-003	20mm	22mm
1640-004	20mm	27mm
1640-005	24mm	31mm

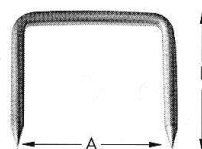

0449-043

Guía centradora de perforación broca diámetro 3.5mm
3.5 mm pointed drill guide

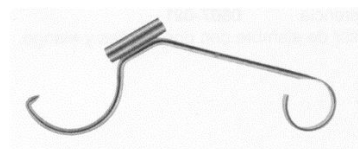

0449-047

Guía centradora de perforación broca diámetro 4.5mm
4.5 mm pointed drill guide

Double drill sleeve

- GD-1115** Guías de broca dentadas dobles 1.1-1.5 mm
- GD-2027** Guías de broca dentadas dobles 2.0-2.7 mm
- GD-2535** Guías de broca dentadas dobles 2.5-3.5 mm
- GD-3245** Guías de broca dentadas dobles 3.2-4.5 mm
- GD-3265** Guías de broca dentadas dobles 3.2-6.5 mm



0449-025 Guía tres orificios paralelos de 2.0 mm
Parallel drill guide 2.0 mm diameter



G-0 Guía para controlar desviaciones en las osteotomías
Jig to avoid deviations in osteotomies



Drill guide 2500-015, 2500-020, 2500-025 or 2500-032 can be inserted in the hole of the arm of the jig

Periostotomos *Periosteal elevator*

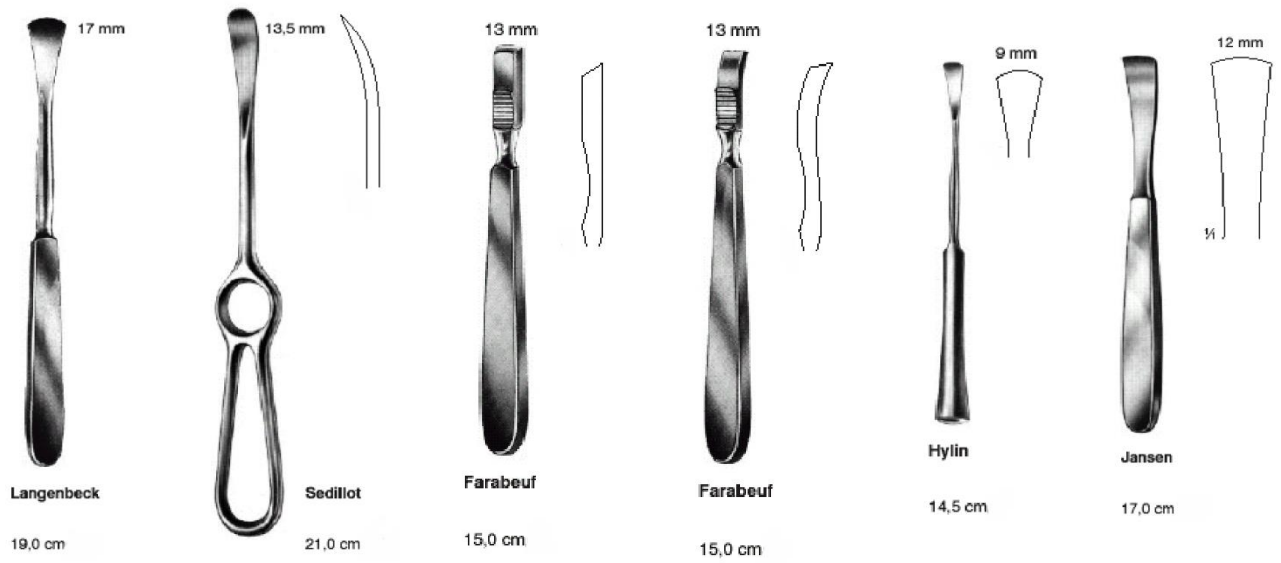

PL-000 PS-000 F-000 F-002 H-000 J-000

Separadores

S-1



S-2



S-3



S-4



S-5



S-6



Compás: permite hacer cortes circulares y en cuña con una fresa (referencia Drem-6 (pag 65))

